



# Code for Special Contacts

## Nummernschlüssel für Sonderkontakte

Ordering Code

### Bestellschlüssel

	FMX	006	P	102	K
<b>Series / Baureihe</b>					
<b>FMX</b> Coaxial contacts for cable termination / <i>Koaxialkontakt für Kabelanschluss</i>					
<b>FMS</b> Coaxial contacts for cable termination / <i>Koaxialkontakt für Kabelanschluss</i>					
<b>FME</b> Coaxial contacts for PCB termination / <i>Koaxialkontakt für Leiterplattenanschluss</i>					
<b>FBM</b> Coaxial contacts (blind mate) / <i>Koaxialkontakt (Blind mate)</i>					
<b>FMP</b> High power contacts / <i>Hochstromkontakt</i>					
<b>FMV</b> High voltage contacts / <i>Hochspannungskontakt</i>					
<b>FMG</b> Pneumatic contacts / <i>Pneumatikkontakt</i>					
<b>Contact version (consecutively numbered) / Kontaktausführung (fortlaufende Nummer)</b>					
<b>Contact type / Kontaktart</b>					
<b>P</b> Pin contact or plug, for coaxial contacts: outer conductor - pin, inner conductor - socket <i>Stiftkontakt bzw. Stecker, bei Koaxialkontakt gilt: Außenleiter - Stift, Innenleiter - Buchse</i>					
<b>S</b> Socket contact or receptacle, for coaxial contacts: outer conductor - socket, inner conductor - pin <i>Buchsenkontakt bzw. Steckdose, bei Koaxialkontakt gilt: Außenleiter - Buchse, Innenleiter - Stift</i>					
<b>Plating specifications / Oberflächenspezifikation</b>					
<b>Modifications / Modifikationen</b>					

## Series

### Baureihen

#### FMX-Series

##### FMX-Serie

- Coaxial contact for cable termination
- Inner conductor for solder termination
- Outer conductor for solder termination
- Outer conductor for solder or crimp termination
- *Koaxialkontakt für Kabelanschluss*
- *Innenleiter zum Löten*
- *Außenleiter zum Löten*
- *Außenleiter zum Löten oder Crimpen*

#### FMP-Series

##### FMP-Serie

- High power contacts
- *Hochstromkontakte*

## Modifications

### Modifikationen

Modifications / Modifikationen		
<b>B</b>	Socket with 4 slits	<i>Buchse mit vier Schlitzen</i>
<b>E</b>	With earthing spring	<i>mit Erdungsfeder</i>
<b>F</b>	Greased contacts	<i>befettete Kontakte</i>
<b>K</b>	With plastic retention clip	<i>mit Kunststoffhalterung</i>
<b>M</b>	CuBe retention clip	<i>CuBe-Halterung</i>
<b>R</b>	With knurl for secure fixing in the insulator	<i>mit Rändel für festen Sitz im Isolierkörper</i>
<b>U</b>	Narrower insertion zone for a more secure fixing in the insulator with a Cu-Be-retention clip	<i>engeres Einrastmaß für festen Sitz im Isolierkörper mit Cu-Be-Halterung</i>
<b>W</b>	With spring washer	<i>mit Federring</i>

#### FMS-Series

##### FMS-Serie

- Coaxial contact for cable termination
- Inner conductor for crimp or solder termination
- Crimp Snap-In System
- Outer conductor for solder or crimp termination
- *Koaxialkontakt für Kabelanschluss*
- *Innenleiter zum Crimpen oder Löten*
- *Crimp Snap-In System*
- *Außenleiter zum Löten oder Crimpen*

#### FMV-Series

##### FMV-Serie

- High voltage contacts
- *Hochspannungskontakte*

#### FME-Series

##### FME-Serie

- Coaxial contact for PCB termination
- *Koaxialkontakt für Leiterplattenanschluss*

#### FBM-Series

##### FBM-Serie

- Coaxial contact for D-Sub / Blind mate / For hidden mounting, e.g. in drawers for frequencies up to 3.5 GHz.
- *Koaxialkontakte für D-Sub / Blind mate / Für verdecktes Stecken z. B. bei Einschubschächten für Frequenzen bis zu 3,5 GHz*

#### FMG-Series

##### FMG-Serie

- Pneumatic contacts
- *Pneumatikkontakte*



# Plating Specifications for the Series FMX, FMS, FME and FBM

## Oberflächenspezifikationen für die Baureihen FMX, FMS, FME und FBM

	Mating Area / <i>Steckbereich</i>		Termination Area / <i>Anschlussbereich</i>		RoHS	Comment / <i>Bemerkung</i>
	Outer Conductor / <i>Außenleiter</i>	Inner Conductor / <i>Innenleiter</i>	Inner Conductor / <i>Innenleiter</i>	Outer Conductor / <i>Außenleiter</i>		
101	0,2 µm (8 microinches) Au over Ni / <i>Au über Ni</i>	0,2 µm (8 microinches) Au over Ni / <i>Au über Ni</i>	0,2 µm (8 microinches) Au over Ni / <i>Au über Ni</i>	5 µm (200 microinches) Sn over Ni / <i>Sn über Ni</i>	•	Low cost
102	0,8 µm (30 microinches) Au over Ni / <i>Au über Ni</i>	1,3 µm (50 microinches) Au over Ni / <i>Au über Ni</i>	1,3 µm (50 microinches) Au over Ni / <i>Au über Ni</i>	0,2 µm (8 microinches) Au over Ni / <i>Au über Ni</i>	•	Standard
108	0,8 µm (30 microinches) Au over Ni / <i>Au über Ni</i>	1,3 µm (50 microinches) Au over Ni / <i>Au über Ni</i>	1,3 µm (50 microinches) Au over Ni / <i>Au über Ni</i>	5 µm (200 microinches) Sn over Ni / <i>Sn über Ni</i>	•	
111	0,8 µm (30 microinches) Au over Cu / <i>Au über Cu</i>	1,3 µm (50 microinches) Au over Cu / <i>Au über Cu</i>	1,3 µm (50 microinches) Au over Cu / <i>Au über Cu</i>	0,2 µm (8 microinches) Au over Cu / <i>Au über Cu</i>	•	Non-magnetic
128	5 µm (200 microinches) Au over Cu / <i>Au über Cu</i>	5 µm (200 microinches) Au over Cu / <i>Au über Cu</i>	5 µm (200 microinches) Au over Cu / <i>Au über Cu</i>	5 µm (200 microinches) Sn over Ag over Cu / <i>Sn über Ag über Cu</i>	•	Non-magnetic
154	0,8 µm (30 microinches) Au over Ni / <i>Au über Ni</i>	1,3 µm (50 microinches) Au over Ni / <i>Au über Ni</i>	1,3 µm (50 microinches) Au over Ni / <i>Au über Ni</i>	0,2 µm (8 microinches) Au over Ni / <i>Au über Ni</i>	•	CuBe design <i>CuBe-Ausführung</i>
201	0,1 µm (4 microinches) Au over NiP / <i>Au über NiP</i>	0,1 µm (4 microinches) Au over NiP / <i>Au über NiP</i>	0,1 µm (4 microinches) Au over NiP / <i>Au über NiP</i>	5 µm (200 microinches) Sn over Ni / <i>Sn über Ni</i>	•	AuroPur / Tin
202	0,1 µm (4 microinches) Au over NiP / <i>Au über NiP</i>	0,1 µm (4 microinches) Au over NiP / <i>Au über NiP</i>	0,1 µm (4 microinches) Au over NiP / <i>Au über NiP</i>	0,2 µm (8 microinches) Au over Ni / <i>Au über Ni</i>	•	AuroPur

Further platings on request / *Weitere Oberflächen auf Anfrage*

# Plating Specifications (High Power Contacts)

## Oberflächenspezifikationen (Hochstromkontakte)

	Mating Area / <i>Steckbereich</i>		Termination Area / <i>Anschlussbereich</i>		RoHS	Comment / <i>Bemerkung</i>
	Material <i>Material</i>	Plating <i>Oberfläche</i>	Material <i>Material</i>	Plating <i>Oberfläche</i>		
103	Cu-alloy <i>Kupferlegierung</i>	0,8 µm (30 microinches) Au over Ni / <i>Au über Ni</i>	Cu-alloy <i>Kupferlegierung</i>	0,2 µm (8 microinches) Au over Ni / <i>Au über Ni</i>	•	Standard
104	Cu-alloy <i>Kupferlegierung</i>	0,8 µm (30 microinches) Au over Ni / <i>Au über Ni</i>	Cu-alloy <i>Kupferlegierung</i>	5 µm (200 microinches) Sn over Ni / <i>Sn über Ni</i>	•	Standard
105	Cu-alloy <i>Kupferlegierung</i>	0,2 µm (8 microinches) Au over Ni / <i>Au über Ni</i>	Cu-alloy <i>Kupferlegierung</i>	5 µm (200 microinches) Sn over Ni / <i>Sn über Ni</i>	•	Low cost
106	Cu-alloy <i>Kupferlegierung</i>	0,2 µm (8 microinches) Au over Ni / <i>Au über Ni</i>	Cu-alloy <i>Kupferlegierung</i>	0,2 µm (8 microinches) Au over Ni / <i>Au über Ni</i>	•	Low cost crimp connection <i>Low cost Crimpanschluss</i>
113	Cu-alloy <i>Kupferlegierung</i>	1,3 µm (50 microinches) Au over Ni / <i>Au über Ni</i>	Cu-alloy <i>Kupferlegierung</i>	5 µm (200 microinches) Sn over Ni / <i>Sn über Ni</i>	•	
133	Cu-alloy <i>Kupferlegierung</i>	5 µm (200 microinches) Au over Cu / <i>Au über Cu</i>	Cu-alloy <i>Kupferlegierung</i>	5 µm (200 microinches) Sn over Ag over Cu / <i>Sn über Ag über Cu</i>	•	Non-magnetic
140	Cu-alloy <i>Kupferlegierung</i>	0,2 µm (8 microinches) Au over Ni / <i>Au über 2 µm Ni</i>	Cu-alloy <i>Kupferlegierung</i>	1 - 1,5 µm (40 - 60 microinches) Sn over Ni / <i>Sn über Ni</i>	•	Low cost press-fit <i>Low cost Einpresstechnik</i>
141	Cu-alloy <i>Kupferlegierung</i>	0,8 µm (30 microinches) Au over Ni / <i>Au über Ni</i>	Cu-alloy <i>Kupferlegierung</i>	1 - 1,5 µm (40 - 60 microinches) Sn over Ni / <i>Sn über Ni</i>	•	Standard press-fit <i>Standard Einpresstechnik</i>
187	Cu-alloy <i>Kupferlegierung</i>	0,8 µm (30 microinches) Au over Cu / <i>Au über Cu</i>	Cu-alloy <i>Kupferlegierung</i>	0,2 µm (8 microinches) Au over Cu / <i>Au über Cu</i>	•	Intermodulation sensitive
203	Cu-alloy <i>Kupferlegierung</i>	0,1 µm (4 microinches) Au over NiP / <i>Au über NiP</i>	Cu-alloy <i>Kupferlegierung</i>	5 µm (200 microinches) Sn over Ni / <i>Sn über Ni</i>	•	AuroPur / Tin
204	Cu-alloy <i>Kupferlegierung</i>	0,1 µm (4 microinches) Au over NiP / <i>Au über NiP</i>	Cu-alloy <i>Kupferlegierung</i>	0,2 µm (8 microinches) Au over Ni / <i>Au über Ni</i>	•	AuroPur

Further platings on request / *Weitere Oberflächen auf Anfrage*

# Wire Cross-section

## Leiterquerschnitt

AWG	Wire Cross-section / <i>Leiterquerschnitt</i>										
	8	10	12	14	16	18	20	22	24	26	28
Wire Construction, n x conductor diameter <i>Leiteraufbau, n x Drahtdurchmesser</i>	133 x 0,29	37 x 0,4	19 x 0,46	19 x 0,36	19 x 0,29	19 x 0,25	19 x 0,20	19 x 0,16	19 x 0,13	19 x 0,10	19 x 0,08
Metrical cross-section (mm <sup>2</sup> ) <i>metrischer Querschnitt (mm<sup>2</sup>)</i>	8,60	4,75	3,09	1,95	1,23	0,96	0,62	0,38	0,24	0,16	0,09
Wire outer diameter <i>Außendurchmesser Leiter</i>	3,73	2,92	2,37	1,85	1,47	1,25	0,94	0,79	0,61	0,51	0,41

# Coaxial Contacts

## Koaxialkontakte

### Technical Data

#### Technische Daten

##### Mechanical Data

##### Mechanische Daten

Mechanical Data Mechanische Daten	
Mating and unmating force (pair of contacts) Steck- und Ziehkräfte (Kontaktpaar)	≤ 7 N
Recommended temperature range Empfohlener Temperaturbereich	-55 °C bis 135 °C (-67 °F to 275 °F)
Mating cycles (Standard) Steckzyklen (Standard)	≥ 500
Mating cycles (low cost) Steckzyklen (Low cost)	≥ 200

##### Electrical Data

##### Elektrische Daten

Electrical Data Elektrische Daten	
Characteristic impedance Wellenwiderstand	50 Ω / 75 Ω
Insulation resistance Isolationswiderstand	≥ 10 G Ω
Contact resistance inner conductor Durchgangswiderstand Innenleiter	≤ 2,7 mΩ
Contact resistance outer conductor Durchgangswiderstand Außenleiter	≤ 2,7 mΩ
Dielectric withstanding voltage Spannungsfestigkeit	750 V / 50 Hz
Working voltage Betriebsspannung	250 Vrms
Current rating (DC) Max. Kontaktstrom (DC)	2 A

##### Materials

##### Materialien

Materials Materialien	
Outer conductor Außenleiter	Cu alloy Cu Legierung
Inner conductor Innenleiter	Cu alloy Cu Legierung
Retaining clip Halteclip	Cu alloy Cu Legierung
Insulators Isolierteile	PTFE / PBTP / PI

# VSWR Measurements (Examples)

## VSWR Messungen (Beispiele)

### VSWR

#### VSWR

The ratio of the maximum to minimum value of the voltage amplitude on a lead is known as the VSWR value. The quotient is a measurement of the quality of the adaptation or of the fluctuation of the resulting voltage surge. In the case of a mismatch, the outward wave is reflected onto the contact point. By superimposing the outward and return waves, a greater difference is obtained between the maximum and minimum voltage than for the outward wave. The VSWR value is 1.0 for a perfect adaptation. The reciprocal value is known as the adaptation factor  $m$ .

*Das Verhältnis von Maximal- zu Minimalwert der Spannungsamplitude auf einer Leitung wird mit VSWR Wert bezeichnet. Der Quotient ist ein Maß für die Qualität der Anpassung bzw. der Welligkeit der resultierenden Spannungswelle. Bei Fehlanpassung wird die hinlaufende Welle an der Kontaktstelle reflektiert. Durch die Überlagerung der hinlaufenden und der rücklaufenden Spannungswelle ergibt sich für die resultierende ein größerer Unterschied zwischen der maximalen und der minimalen Spannungsamplitude als bei der hinlaufenden Welle. Der VSWR-Wert ist im Idealfall der Anpassung gleich 1.0, den Kehrwert bezeichnet man als Anpassungsfaktor  $m$ .*

$r$ : Reflection factor / Reflexionsfaktor

$m$ : Adaptation factor / Anpassungsfaktor

$a$ : Return loss / Rückflußdämpfung

VSWR: Voltage standing wave ratio / Stehwellenverhältnis

$$VSWR = \frac{U_{\max}}{U_{\min}} = \frac{1+r}{1-r} \quad r = \frac{VSWR - 1}{VSWR + 1} \quad m = \frac{1}{VSWR} \quad a = -20 \lg \frac{VSWR + 1}{VSWR - 1}$$

#### FMS001P102 / ...S102 (Straight Contacts / gerade Kontakte)

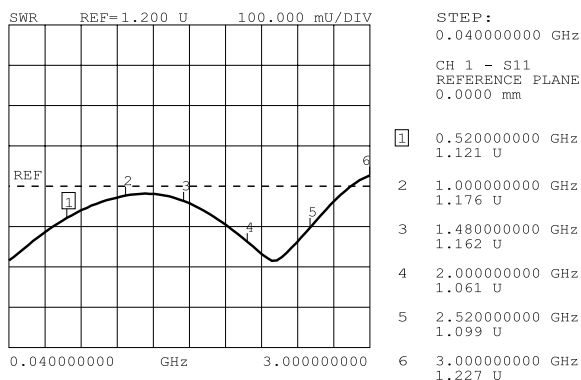

#### FMS015P102/ ...S102 (Right Angled Contacts / abgewinkelte Kontakte)

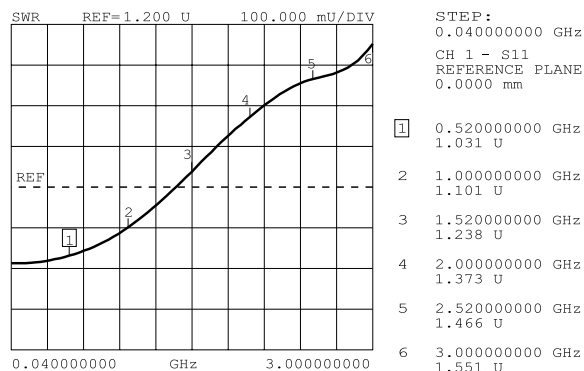

#### FBM004P170 / ...S170 (Straight Contacts / gerade Kontakte)

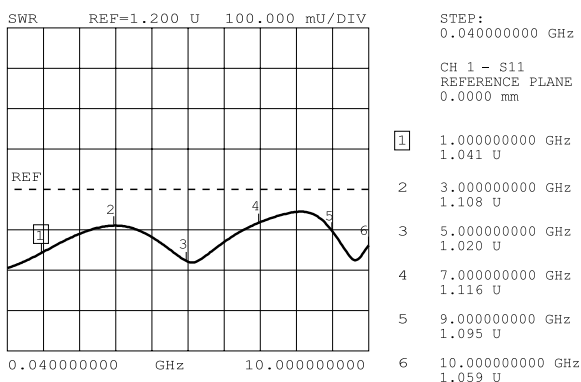

#### FMX006P102 / ...S102 (Straight Contacts / gerade Kontakte)

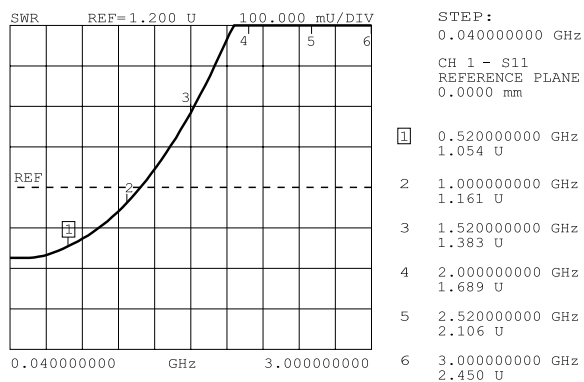



# Coaxial Contacts, Mating Area Dimensions, Pin Diameter 1 mm (0.039")

## Koaxialkontakte, Abmessungen Steckbereich, Pindurchmesser 1 mm

**Plug**

**Stecker**

**Socket**

**Buchse**

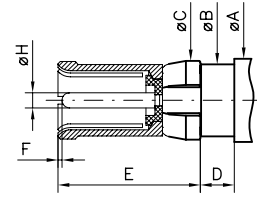
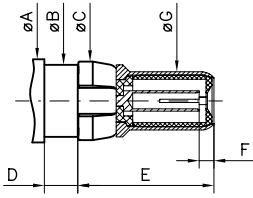

	Plug / Stecker		Socket / Buchse			
	min	max.	min		max.	
			Modi. U*		Modi. U*	
<b>ØA</b>	—	5,50 (0.217)	—		5,50 (0.217)	
<b>ØB</b>	4,75 (0.187)	4,80 (0.189)	4,75 (0.187)		4,80 (0.189)	
<b>ØC</b>	5,00 (0.197)	5,40 (0.213)	5,00 (0.197)		5,40 (0.213)	
<b>D</b>	2,25 (0.089)	2,45 (0.096)	2,25 (0.089)	2,10 (0.083)	2,45 (0.096)	2,25 (0.089)
<b>E</b>	—	9,00 (0.354)	—		9,5 (0.374)	
<b>F</b>	—	approx. 1,0 ca. 1,0	0,10 (0.004)		0,50 (0.020)	
<b>ØG</b>	3,83 (0.151)	3,87 (0.152)	—		—	
<b>ØH</b>	—	—	0,98 (0.039)		1,02 (0.040)	

Modification U\* please see page 26

Modifikation U\* siehe Seite 26



# FMX Coaxial Contacts, 50 Ohm, Straight Cable Termination

## FMX Koaxialkontakte, 50 Ohm, gerader Kabelanschluss

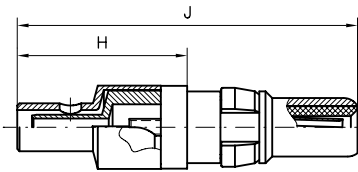

Inner Conductor <i>Innenleiter</i>	Outer Conductor <i>Außenleiter</i>
Solder termination <i>Löten</i>	Crimp or solder termination <i>Crimpen oder Löten</i>

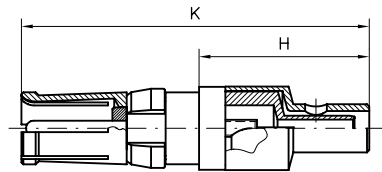

Order Number Plug <i>Bestellnummer Stecker</i>	Type <i>Ausführung</i>	Platings / <i>Oberflächen</i>				Suitable Cables RG- <i>Verwendbare Kabel RG-</i>	Order Number Receptacles <i>Bestellnummer Steckdose</i>
		Mating Area <i>Steckbereich</i>		Termination Area <i>Anschlussbereich</i>			
		Inner Conductor <i>Innenleiter</i>	Outer Conductor <i>Außenleiter</i>	Inner Conductor <i>Innenleiter</i>	Outer Conductor <i>Außenleiter</i>		
FMX005P102	standard	1,3 µm Au	0,8 µm Au	1,3 µm Au	0,2 µm Au	178BU	FMX005S102
FMX005P101	low cost	0,2 µm Au	0,2 µm Au	0,2 µm Au	5 µm Sn	196AU, 404U	FMX005S101
FMX005P202	standard	AuroPur	AuroPur	AuroPur	0,2 µm Au	178BU	FMX005S202
FMX005P201	low cost	AuroPur	AuroPur	AuroPur	5 µm Sn	196AU, 404U	FMX005S201
FMX006P102*	standard	1,3 µm Au	0,8 µm Au	1,3 µm Au	0,2 µm Au	174U	FMX006S102*
FMX006P101*	low cost	0,2 µm Au	0,2 µm Au	0,2 µm Au	5 µm Sn	188AU, 316U	FMX006S101*
FMX007P102*	standard	1,3 µm Au	0,8 µm Au	1,3 µm Au	0,2 µm Au	180BU	FMX007S102*
FMX007P101*	low cost	0,2 µm Au	0,2 µm Au	0,2 µm Au	5 µm Sn		FMX007S101*
FMX008P102	standard	1,3 µm Au	0,8 µm Au	1,3 µm Au	0,2 µm Au	58CU, 141AU	FMX008S102
FMX008P101	low cost	0,2 µm Au	0,2 µm Au	0,2 µm Au	5 µm Sn		FMX008S101
FMX012P102	standard	1,3 µm Au	0,8 µm Au	1,3 µm Au	0,2 µm Au	316U double braided <i>doppelt geschirmt</i>	FMX012S102
FMX012P101	low cost	0,2 µm Au	0,2 µm Au	0,2 µm Au	5 µm Sn		FMX012S101

Other platings on request / *Andere Oberflächen auf Anfrage*  
Tools from page 94 onwards / *Werkzeuge ab Seite 94 ff.*

8 microinches =  $\approx 0,2 \mu\text{m}$   
30 microinches =  $\approx 0,8 \mu\text{m}$

50 microinches =  $\approx 1,3 \mu\text{m}$   
200 microinches =  $\approx 5 \mu\text{m}$

\* Deep-drawn crimp ferrule without inspection hole, please see illustration on page 32.

\* *Tiefgezogene Crimphülse ohne Inspektionsbohrung, siehe Darstellung auf Seite 32.*

### Dimensions

#### Abmessungen

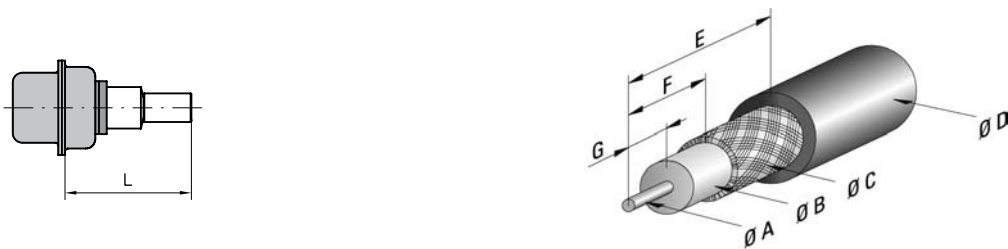

Order Number <i>Bestellnummer</i>	Ø A max.	Ø B max.	Ø C max.	Ø D max.	E	F	G	H	J	K	L
FMX005...	0,85 (0.033)	1,2 (0.047)	1,4 (0.055)	2,3 (0.091)	9,5 (0.374)	5,0 (0.197)	3,0 (0.118)	11,2 (0.441)	22,5 (0.886)	23,0 (0.906)	16,7 (0.657)
FMX006...	0,85 (0.033)	1,9 (0.075)	2,3 (0.091)	3,2 (0.126)	9,5 (0.374)	5,0 (0.197)	3,0 (0.118)	11,2 (0.441)	22,5 (0.886)	23,0 (0.906)	16,7 (0.657)
FMX007...	0,85 (0.033)	2,8 (0.110)	3,1 (0.122)	4,5 (0.177)	9,5 (0.374)	5,0 (0.197)	3,0 (0.118)	11,2 (0.441)	22,5 (0.886)	23,0 (0.906)	16,7 (0.657)
FMX008...	1,0 (0.039)	3,0 (0.118)	3,6 (0.142)	5,2 (0.205)	9,5 (0.374)	5,0 (0.197)	3,0 (0.118)	13,6 (0.535)	26,3 (1.035)	26,8 (1.055)	19,0 (0.748)
FMX012...	0,85 (0.033)	1,9 (0.075)	2,7 (0.106)	3,2 (0.126)	9,5 (0.374)	5,0 (0.197)	3,0 (0.118)	12,2 (0.480)	23,5 (0.925)	24,0 (0.945)	17,3 (0.681)



# FMX Coaxial Contacts, 50 Ohm, Right Angled Cable Termination

## FMX Koaxialkontakte, 50 Ohm, abgewinkelter Kabelanschluss

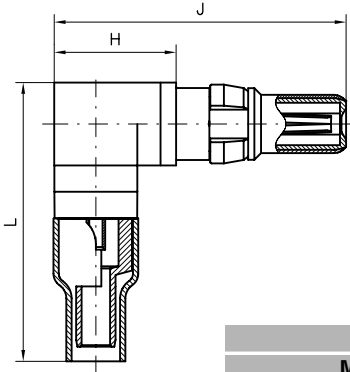

<b>Inner Conductor</b> <i>Innenleiter</i>	<b>Outer Conductor</b> <i>Außenleiter</i>
<b>Solder termination</b> <i>Löten</i>	<b>Crimp or solder termination</b> <i>Crimpen oder Löten</i>

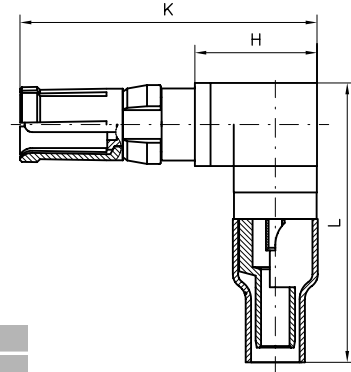

### Platings / Oberflächen

Order Number Plug <i>Bestellnummer Stecker</i>	Type <i>Ausführung</i>	Mating Area <i>Steckbereich</i>		Termination Area <i>Anschlussbereich</i>		Suitable Cables RG- <i>Verwendbare Kabel RG-</i>	Order Number Receptacles <i>Bestellnummer Steckdose</i>
		Inner Conductor <i>Innenleiter</i>	Outer Conductor <i>Außenleiter</i>	Inner Conductor <i>Innenleiter</i>	Outer Conductor <i>Außenleiter</i>		
FMX029P102	standard	1,3 µm Au	0,8 µm Au	1,3 µm Au	0,2 µm Au	174U,	FMX029S102
FMX029P101	low cost	0,2 µm Au	0,2 µm Au	0,2 µm Au	5 µm Sn	188AU, 316U	FMX029S101
FMX029P202	standard	AuroPur	AuroPur	AuroPur	0,2 µm Au	174U,	FMX029S202
FMX029P201	low cost	AuroPur	AuroPur	AuroPur	5 µm Sn	188AU, 316U	FMX029S201
FMX031P102*	standard	1,3 µm Au	0,8 µm Au	1,3 µm Au	0,2 µm Au	178BU,	FMX031S102*
FMX031P101*	low cost	0,2 µm Au	0,2 µm Au	0,2 µm Au	5 µm Sn	196AU, 404U	FMX031S101*
FMX032P102*	standard	1,3 µm Au	0,8 µm Au	1,3 µm Au	0,2 µm Au	316U double braided	FMX032S102*
FMX032P101*	low cost	0,2 µm Au	0,2 µm Au	0,2 µm Au	5 µm Sn	<i>doppelt geschirmt</i>	FMX032S101*

Other platings on request / *Andere Oberflächen auf Anfrage*  
Tools from page 94 onwards / *Werkzeuge ab Seite 94 ff.*

8 microinches =  $\approx 0,2 \mu\text{m}$   
30 microinches =  $\approx 0,8 \mu\text{m}$

50 microinches =  $\approx 1,3 \mu\text{m}$   
200 microinches =  $\approx 5 \mu\text{m}$

\* Turned crimp ferrule with inspection hole, please see illustration on page 31.  
\* *Gedrehte Crimphülse mit Inspektionsbohrung, siehe Darstellung auf Seite 31.*

### Dimensions

#### Abmessungen

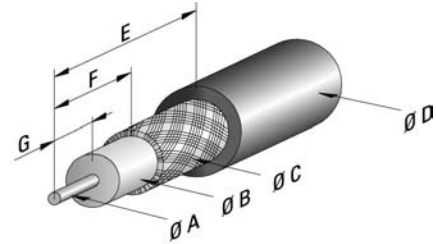
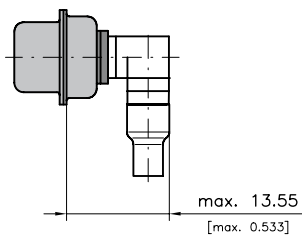

Order Number <i>Bestellnummer</i>	Ø A max.	Ø B max.	Ø C max.	Ø D max.	E	F	G	H	J	K	L
FMX029...	0,85 (0.033)	1,9 (0.075)	2,3 (0.091)	3,2 (0.126)	9,5 (0.374)	5,0 (0.197)	3,0 (0.118)	8,00 (0.315)	19,3 (0.760)	19,8 (0.780)	18,5 (0.728)
FMX031...	0,85 (0.033)	1,2 (0.047)	1,4 (0.055)	2,3 (0.091)	9,5 (0.374)	5,0 (0.197)	3,0 (0.118)	8,00 (0.315)	19,3 (0.760)	19,8 (0.780)	18,5 (0.728)
FMX032...	0,85 (0.033)	1,9 (0.075)	2,7 (0.106)	3,2 (0.126)	9,5 (0.374)	5,0 (0.197)	3,0 (0.118)	8,00 (0.315)	19,3 (0.760)	19,8 (0.780)	19,5 (0.768)



# FMX Coaxial Contacts, 75 Ohm, Straight Cable Termination

## FMX Koaxialkontakte, 75 Ohm, gerader Kabelanschluss

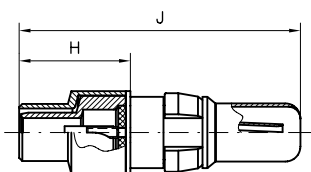

Inner Conductor <i>Innenleiter</i>	Outer Conductor <i>Außenleiter</i>
Solder termination <i>Löten</i>	Crimp or solder termination <i>Crimpen oder Löten</i>

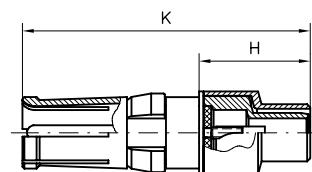

Order Number Plug <i>Bestellnummer Stecker</i>	Type <i>Ausführung</i>	Platings / <i>Oberflächen</i>				Suitable Cables RG- <i>Verwendbare Kabel RG-</i>	Order Number Receptacles <i>Bestellnummer Steckdose</i>
		Mating Area <i>Steckbereich</i>		Termination Area <i>Anschlussbereich</i>			
		Inner Conductor <i>Innenleiter</i>	Outer Conductor <i>Außenleiter</i>	Inner Conductor <i>Innenleiter</i>	Outer Conductor <i>Außenleiter</i>		
FMX002P102 *	standard	1,3 µm Au	0,8 µm Au	1,3 µm Au	0,2 µm Au	179BU, 187AU	FMX002S102 *
FMX002P101 *	low cost	0,2 µm Au	0,2 µm Au	0,2 µm Au	5 µm Sn		FMX002S101 *
FMX002P202 *	standard	AuroPur	AuroPur	AuroPur	0,2 µm Au	179BU, 187AU	FMX002S202 *
FMX002P201 *	low cost	AuroPur	AuroPur	AuroPur	5 µm Sn		FMX002S201 *
FMX003P102 **	standard	1,3 µm Au	0,8 µm Au	1,3 µm Au	0,2 µm Au	179BU, 187AU	FMX003S102 **
FMX003P101 **	low cost	0,2 µm Au	0,2 µm Au	0,2 µm Au	5 µm Sn		FMX003S101 **

Other platings on request / *Andere Oberflächen auf Anfrage*

Tools from page 94 onwards / *Werkzeuge ab Seite 94 ff*

8 microinches =  $\approx 0,2 \mu\text{m}$

30 microinches =  $\approx 0,8 \mu\text{m}$

50 microinches =  $\approx 1,3 \mu\text{m}$

200 microinches =  $\approx 5 \mu\text{m}$

\* Short version / *kurze Version*

\*\* Deep-drawn crimp ferrule without inspection hole, please see illustration on page 32.

\*\* *Tiefgezogene Crimphülse ohne Inspektionsbohrung, siehe Darstellung auf Seite 32.*

### Dimensions

#### Abmessungen

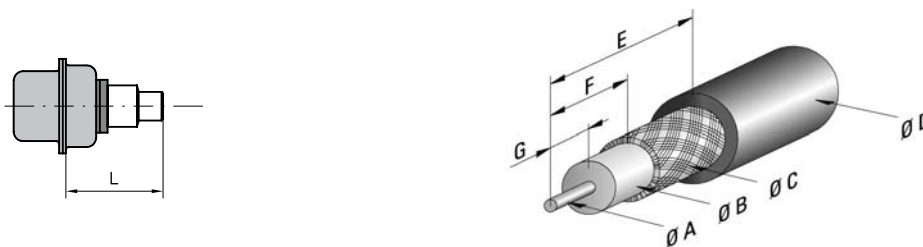

Order Number <i>Bestellnummer</i>	Ø A max.	Ø B max.	Ø C max.	Ø D max.	E	F	G	H	J	K	L
FMX002...	0,5 (0.020)	1,9 (0.075)	2,3 (0.091)	3,2 (0.126)	6,0 (0.236)	3,1 (0.122)	2,0 (0.079)	7,3 (0.287)	18,55 (0.730)	19,05 (0.750)	12,8 (0.504)
FMX003...	0,5 (0.020)	1,9 (0.075)	2,3 (0.091)	3,2 (0.126)	9,5 (0.374)	5,0 (0.197)	3,0 (0.118)	11,2 (0.441)	22,5 (0.886)	23,0 (0.906)	16,7 (0.657)





# FMS Coaxial Contacts, 50 Ohm, Straight Cable Termination

## FMS Koaxialkontakte, 50 Ohm, gerader Kabelanschluss

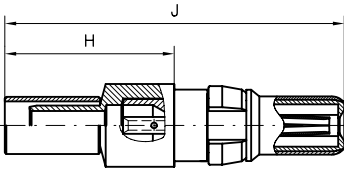

Inner Conductor <i>Innenleiter</i>	Outer Conductor <i>Außenleiter</i>
Crimp termination <i>Crimpen</i>	Crimp termination <i>Crimpen</i>
Crimp snap-in system <i>Crimp Snap-in System</i>	

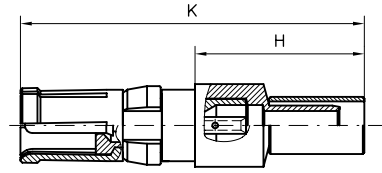

### Platings / Oberflächen

		Mating Area <i>Steckbereich</i>		Termination Area <i>Anschlussbereich</i>	
Order Number <i>Bestellnummer</i>	Type <i>Ausführung</i>	Inner Conductor <i>Innenleiter</i>	Outer Conductor <i>Außenleiter</i>	Inner Conductor <i>Innenleiter</i>	Outer Conductor <i>Außenleiter</i>

Order Number <i>Bestellnummer</i>	Type <i>Ausführung</i>	Inner Conductor <i>Innenleiter</i>	Outer Conductor <i>Außenleiter</i>	Inner Conductor <i>Innenleiter</i>	Outer Conductor <i>Außenleiter</i>	Suitable Cables RG- <i>Verwendbare Kabel RG-</i>	Order Number Receptacles <i>Bestellnummer</i> Steckdose
FMS001P102	standard	1,3 µm Au	0,8 µm Au	1,3 µm Au	0,2 µm Au	174U,	FMS001S102
FMS001P101	low cost	0,2 µm Au	0,2 µm Au	0,2 µm Au	5 µm Sn	188AU, 316U	FMS001S101
FMS001P202	standard	AuroPur	AuroPur	AuroPur	0,2 µm Au	174U,	FMS001S202
FMS001P201	low cost	AuroPur	AuroPur	AuroPur	5 µm Sn	188AU, 316U	FMS001S201
FMS006P102	standard	1,3 µm Au	0,8 µm Au	1,3 µm Au	0,2 µm Au	316U double braided <i>doppelt geschirmt</i>	FMS006S102
FMS006P101	low cost	0,2 µm Au	0,2 µm Au	0,2 µm Au	5 µm Sn		FMS006S101
FMS009P102	standard	1,3 µm Au	0,8 µm Au	1,3 µm Au	0,2 µm Au	58CU, 141AU	FMS009S102
FMS009P101	low cost	0,2 µm Au	0,2 µm Au	0,2 µm Au	5 µm Sn		FMS009S101

Other platings on request / *Andere Oberflächen auf Anfrage*  
Tools from page 94 onwards / *Werkzeuge ab Seite 94 ff.*

8 microinches =  $\approx 0,2 \mu\text{m}$   
30 microinches =  $\approx 0,8 \mu\text{m}$

50 microinches =  $\approx 1,3 \mu\text{m}$   
200 microinches =  $\approx 5 \mu\text{m}$

### Dimensions

#### Abmessungen

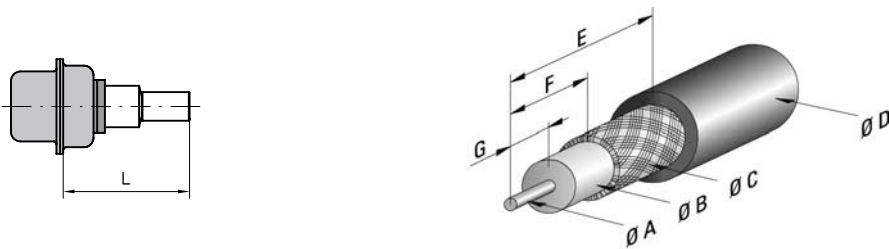

Order Number <i>Bestellnummer</i>	Ø A max.	Ø B max.	Ø C max.	Ø D max.	E	F	G	H approx. ca.	J approx. ca.	K approx. ca.	L
FMS001...	0,6 (0.024)	1,9 (0.075)	2,4 (0.094)	3,2 (0.126)	9,0 (0.354)	4,3 (0.169)	3,0 (0.118)	11,2 (0.441)	22,45 (0.884)	22,95 (0.904)	16,6 (0.654)
FMS006...	0,6 (0.024)	1,9 (0.075)	2,7 (0.106)	3,8 (0.150)	9,3 (0.366)	4,3 (0.169)	3,0 (0.118)	11,2 (0.441)	22,45 (0.884)	22,95 (0.904)	16,6 (0.654)
FMS009...	1,3 (0.051)	3,7 (0.146)	4,5 (0.177)	5,2 (0.205)	8,3 (0.327)	3,6 (0.142)	2,7 (0.106)	10,7 (0.421)	22,15 (0.872)	22,65 (0.892)	16,3 (0.642)



# FMS Coaxial Contacts, 50 Ohm, Right Angled Cable Termination

## FMS Koaxialkontakte, 50 Ohm, abgewinkelter Kabelanschluss

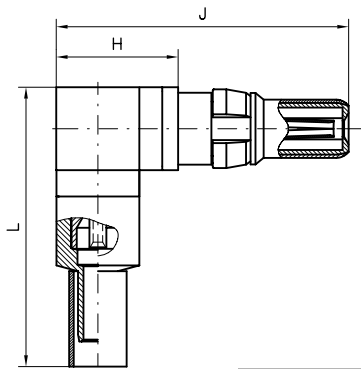

**Inner Conductor**  
*Innenleiter*  
**Outer Conductor**  
*Außenleiter*  
**Crimp termination**  
*Crimpen*  
**Crimp termination**  
*Crimpen*  
**Crimp snap-in system**  
*Crimp Snap-in System*

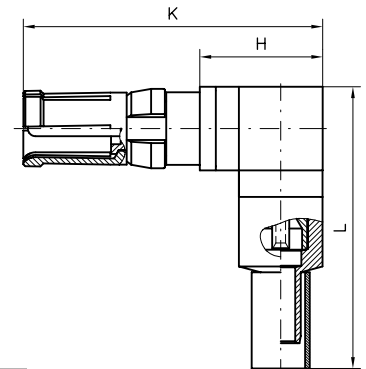

Order Number Plug <i>Bestellnummer Stecker</i>	Type <i>Ausführung</i>	Platings / <i>Oberflächen</i>				Suitable Cables RG- <i>Verwendbare Kabel RG-</i>	Order Number Receptacles <i>Bestellnummer Steckdose</i>
		Mating Area <i>Steckbereich</i>		Termination Area <i>Anschlussbereich</i>			
		Inner Conductor <i>Innenleiter</i>	Outer Conductor <i>Außenleiter</i>	Inner Conductor <i>Innenleiter</i>	Outer Conductor <i>Außenleiter</i>		
FMS012P102	standard	1,3 µm Au	0,8 µm Au	1,3 µm Au	0,2 µm Au	174U	FMS012S102
FMS012P101	low cost	0,2 µm Au	0,2 µm Au	0,2 µm Au	5 µm Sn	188AU, 316U	FMS012S101
FMS012P202	standard	AuroPur	AuroPur	AuroPur	0,2 µm Au	174U	FMS012S202
FMS012P201	low cost	AuroPur	AuroPur	AuroPur	5 µm Sn	188AU, 316U	FMS012S201
FMS022P102	standard	1,3 µm Au	0,8 µm Au	1,3 µm Au	0,2 µm Au	316U double braided <i>doppelt geschirmt</i>	FMS022S102
FMS022P101	low cost	0,2 µm Au	0,2 µm Au	0,2 µm Au	5 µm Sn		FMS022S101
FMS026P102	standard	1,3 µm Au	0,8 µm Au	1,3 µm Au	0,2 µm Au	58 C/U	FMS026S102
FMS026P101	low cost	0,2 µm Au	0,2 µm Au	0,2 µm Au	5 µm Sn		FMS026S101

Other platings on request / *Andere Oberflächen auf Anfrage*  
 Tools from page 94 onwards / *Werkzeuge ab Seite 94 ff.*

8 microinches =  $\approx 0,2 \mu\text{m}$   
 30 microinches =  $\approx 0,8 \mu\text{m}$

50 microinches =  $\approx 1,3 \mu\text{m}$   
 200 microinches =  $\approx 5 \mu\text{m}$

### Dimensions

#### Abmessungen

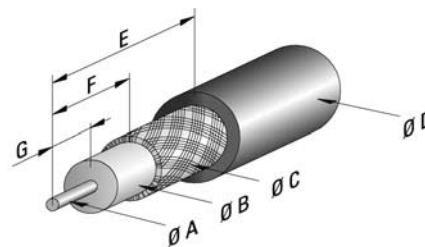
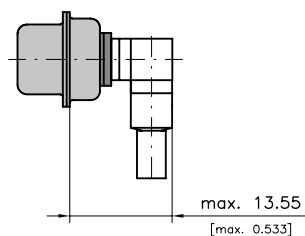

Order Number <i>Bestellnummer</i>	Ø A max.	Ø B max.	Ø C max.	Ø D max.	E	F	G	H	J	K	L approx. ca.
FMS012...	0,6 (0.024)	1,9 (0.075)	2,3 (0.091)	3,2 (0.126)	9,0 (0.354)	3,8 (0.150)	2,3 (0.091)	8,0 (0.315)	19,25 (0.758)	19,8 (0.780)	18,5 (0.728)
FMS022...	0,6 (0.024)	1,9 (0.075)	3,0 (0.118)	3,5 (0.138)	9,0 (0.354)	3,8 (0.150)	2,3 (0.091)	8,05 (0.317)	19,3 (0.760)	19,8 (0.780)	18,5 (0.728)
FMS026...	1,0 (0.039)	3,7 (0.146)	4,3 (0.169)	5,2 (0.205)	8,3 (0.327)	3,6 (0.142)	2,7 (0.106)	8,05 (0.317)	19,3 (0.760)	19,8 (0.780)	18,5 (0.728)



# FMS Coaxial Contacts, 75 Ohm, Straight Cable Termination

## FMS Koaxialkontakte, 75 Ohm, gerader Kabelanschluss

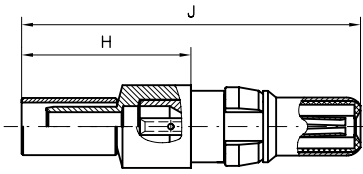

<b>Inner Conductor</b> <i>Innenleiter</i>	<b>Outer Conductor</b> <i>Außenleiter</i>
<b>Crimp termination</b> <i>Crimpen</i>	<b>Crimp termination</b> <i>Crimpen</i>
<b>Crimp snap-in system</b> <i>Crimp Snap-in System</i>	

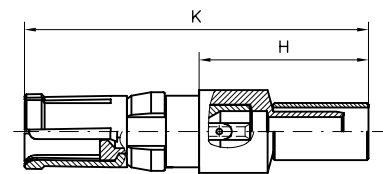

Order Number Plug <i>Bestellnummer Stecker</i>	Type <i>Ausführung</i>	Platings / <i>Oberflächen</i>				Suitable Cables RG- <i>Verwendbare Kabel RG-</i>	Order Number Receptacles <i>Bestellnummer Steckdose</i>
		Mating Area <i>Steckbereich</i>		Termination Area <i>Anschlussbereich</i>			
		Inner Conductor <i>Innenleiter</i>	Outer Conductor <i>Außenleiter</i>	Inner Conductor <i>Innenleiter</i>	Outer Conductor <i>Außenleiter</i>		
FMS002P102	standard	1,3 µm Au	0,8 µm Au	1,3 µm Au	0,2 µm Au	179BU, 187AU	FMS002S102
FMS002P101	low cost	0,2 µm Au	0,2 µm Au	0,2 µm Au	5 µm Sn		FMS002S101
FMS002P202	standard	AuroPur	AuroPur	AuroPur	0,2 µm Au	179BU, 187AU	FMS002S202
FMS002P201	low cost	AuroPur	AuroPur	AuroPur	5 µm Sn		FMS002S201
FMS003P102	standard	1,3 µm Au	0,8 µm Au	1,3 µm Au	0,2 µm Au	180BU	FMS003S102
FMS003P101	low cost	0,2 µm Au	0,2 µm Au	0,2 µm Au	5 µm Sn		FMS003S101

Other platings on request / *Andere Oberflächen auf Anfrage*  
Tools from page 94 onwards / *Werkzeuge ab Seite 94 ff.*

8 microinches =  $\approx 0,2 \mu\text{m}$   
30 microinches =  $\approx 0,8 \mu\text{m}$

50 microinches =  $\approx 1,3 \mu\text{m}$   
200 microinches =  $\approx 5 \mu\text{m}$

### Dimensions

#### Abmessungen

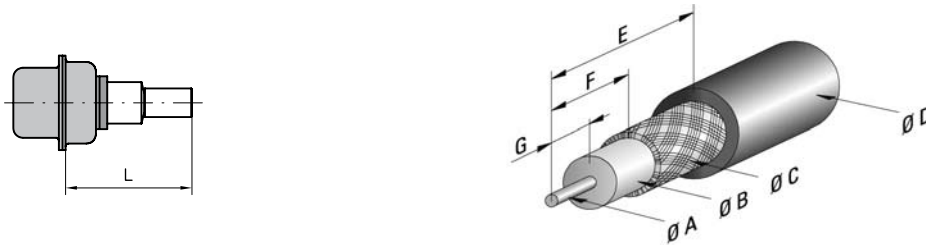

Order Number <i>Bestellnummer</i>	Ø A max.	Ø B max.	Ø C max.	Ø D max.	E	F	G	H approx. ca.	J approx. ca.	K approx. ca.	L
FMS002...	0,6 (0.024)	1,9 (0.075)	2,4 (0.094)	3,2 (0.126)	9,0 (0.354)	4,3 (0.169)	3,0 (0.118)	11,2 (0.441)	22,45 (0.884)	22,95 (0.904)	16,7 (0.657)
FMS003...	0,6 (0.024)	2,8 (0.110)	3,3 (0.130)	4,5 (0.177)	8,5 (0.335)	3,5 (0.138)	3,0 (0.118)	10,2 (0.402)	21,65 (0.852)	22,15 (0.872)	15,9 (0.626)



# FMS Coaxial Contacts, 75 Ohm, Right Angled Cable Termination

## FMS Koaxialkontakte, 75 Ohm, abgewinkelter Kabelanschluss

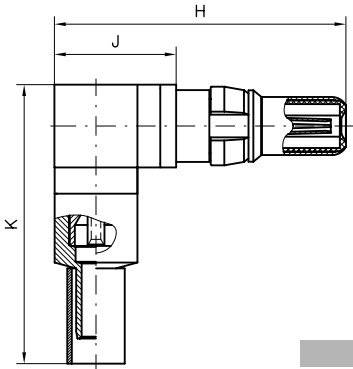

<b>Inner Conductor</b> <i>Innenleiter</i>	<b>Outer Conductor</b> <i>Außenleiter</i>
<b>Crimp termination</b> <i>Crimpen</i>	<b>Crimp termination</b> <i>Crimpen</i>
<b>Crimp snap-in system</b> <i>Crimp Snap-in System</i>	

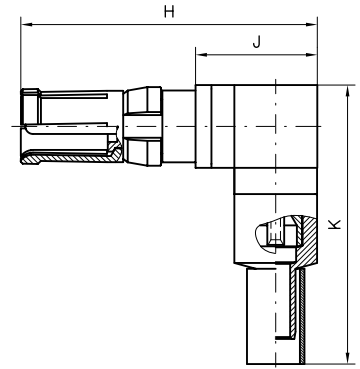

Order Number Plug <i>Bestellnummer Stecker</i>	Type <i>Ausführung</i>	Platings / <i>Oberflächen</i>				Suitable Cables RG- <i>Verwendbare Kabel RG-</i>	Order Number Receptacles <i>Bestellnummer Steckdose</i>
		Mating Area <i>Steckbereich</i>		Termination Area <i>Anschlussbereich</i>			
		Inner Conductor <i>Innenleiter</i>	Outer Conductor <i>Außenleiter</i>	Inner Conductor <i>Innenleiter</i>	Outer Conductor <i>Außenleiter</i>		
FMS015P102	standard	1,3 μm Au	0,8 μm Au	1,3 μm Au	0,2 μm Au	179BU, 187AU	FMS015S102
FMS015P101	low cost	0,2 μm Au	0,2 μm Au	0,2 μm Au	5 μm Sn		FMS015S101
FMS015P202	standard	AuroPur	AuroPur	AuroPur	0,2 μm Au	179BU, 187AU	FMS015S202
FMS015P201	low cost	AuroPur	AuroPur	AuroPur	5 μm Sn		FMS015S201

Other platings on request / *Andere Oberflächen auf Anfrage*  
Tools from page 94 onwards / *Werkzeuge ab Seite 94 ff.*

8 microinches =  $\approx 0,2 \mu\text{m}$   
30 microinches =  $\approx 0,8 \mu\text{m}$

50 microinches =  $\approx 1,3 \mu\text{m}$   
200 microinches =  $\approx 5 \mu\text{m}$

### Dimensions

#### Abmessungen

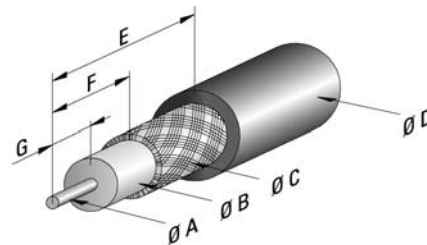
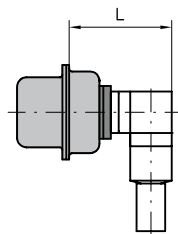

Order Number <i>Bestellnummer</i>	Ø A max.	Ø B max.	Ø C max.	Ø D max.	E	F	G	H	J	K approx. ca.	L
FMS015...	0,6 (0.024)	1,9 (0.075)	2,3 (0.091)	3,2 (0.126)	9,0 (0.354)	3,8 (0.150)	2,3 (0.091)	19,25 (0.758)	8,0 (0.315)	18,5 (0.728)	13,55 (0.533)



# Coaxial Contacts, Mating Area Dimensions, Pin Diameter 0.75 mm (0.030")

## Koaxialkontakte, Abmessungen Steckbereich, Pindurchmesser 0,75 mm

**Plug**

**Stecker**

**Socket**

**Buchse**

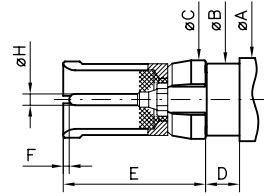
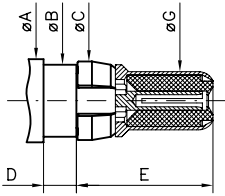

	Plug / Stecker		Socket / Buchse			
	min	max.	min	max.		
				Modi. U*		Modi. U*
<b>ØA</b>	—	5,50 (0.217)	—		5,50 (0.217)	
<b>ØB</b>	4,75 (0.187)	4,80 (0.189)	4,75 (0.187)		4,80 (0.189)	
<b>ØC</b>	5,00 (0.197)	5,40 (0.213)	5,00 (0.197)		5,40 (0.213)	
<b>D</b>	2,25 (0.089)	2,45 (0.096)	2,25 (0.089)	2,10 (0.083)	2,45 (0.096)	2,25 (0.089)
<b>E</b>	—	9,00 (0.354)	—		9,5 (0.374)	
<b>F</b>	—	—	0,10 (0.004)		0,50 (0.020)	
<b>ØG</b>	3,83 (0.151)	3,87 (0.152)	—		—	
<b>ØH</b>	—	—	0,74 (0.029)		0,76 (0.030)	

Modification U\* please see page 26

Modifikation U\* siehe Seite 26



# FMS Coaxial Contacts, 50 Ohm, Straight Cable Termination, Pin Diameter 0.75 mm (0.030")

## FMS Koaxialkontakte, 50 Ohm, gerader Kabelanschluss, Pindurchmesser 0,75 mm

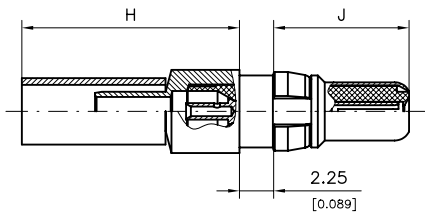

Inner Conductor <i>Innenleiter</i>	Outer Conductor <i>Außenleiter</i>
Crimp termination <i>Crimpen</i>	Crimp termination <i>Crimpen</i>
Crimp snap-in system <i>Crimp Snap-in System</i>	

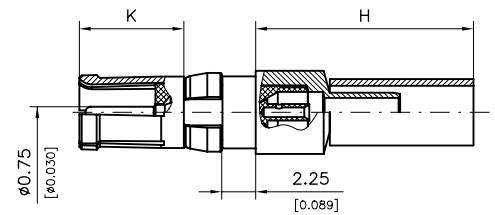

Order Number Plug <i>Bestellnummer Stecker</i>	Type <i>Ausführung</i>	Platings / <i>Oberflächen</i>				Suitable Cables RG- <i>Verwendbare Kabel RG-</i>	Order Number Receptacles <i>Bestellnummer Steckdose</i>
		Mating Area <i>Steckbereich</i>		Termination Area <i>Anschlussbereich</i>			
		Inner Conductor <i>Innenleiter</i>	Outer Conductor <i>Außenleiter</i>	Inner Conductor <i>Innenleiter</i>	Outer Conductor <i>Außenleiter</i>		
FMS016P102	standard	1,3 µm Au	0,8 µm Au	1,3 µm Au	0,2 µm Au	316U double braided <i>doppelt geschirmt</i>	FMS016S102
FMS016P101	low cost	0,2 µm Au	0,2 µm Au	0,2 µm Au	5 µm Sn	316U double braided <i>doppelt geschirmt</i>	FMS016S101
FMS016P202	standard	AuroPur	AuroPur	AuroPur	0,2 µm Au		FMS016S202
FMS016P201	low cost	AuroPur	AuroPur	AuroPur	5 µm Sn		FMS016S201

Other platings on request / *Andere Oberflächen auf Anfrage*  
Tools from page 94 onwards / *Werkzeuge ab Seite 94 ff.*

8 microinches = ≈ 0,2 µm  
30 microinches = ≈ 0,8 µm  
50 microinches = ≈ 1,3 µm  
200 microinches = ≈ 5 µm

# FMX Coaxial Contacts, 50 Ohm, Straight Cable Termination, Pin Diameter 0.75 mm (0.030")

## FMX Koaxialkontakte, 50 Ohm, gerader Kabelanschluss, Pindurchmesser 0,75 mm

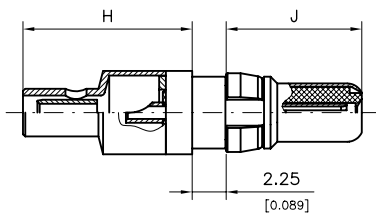

Inner Conductor <i>Innenleiter</i>	Outer Conductor <i>Außenleiter</i>
—	Crimp termination <i>Crimpen</i>
Solder termination <i>Löten</i>	Solder termination <i>Löten</i>

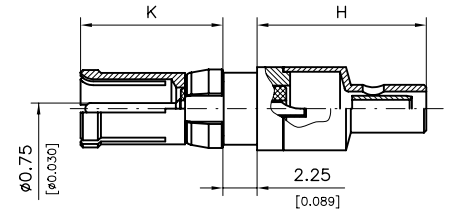

Order Number Plug <i>Bestellnummer Stecker</i>	Type <i>Ausführung</i>	Platings / <i>Oberflächen</i>				Suitable Cables RG- <i>Verwendbare Kabel RG-</i>	Order Number Receptacles <i>Bestellnummer Steckdose</i>
		Mating Area <i>Steckbereich</i>		Termination Area <i>Anschlussbereich</i>			
		Inner Conductor <i>Innenleiter</i>	Outer Conductor <i>Außenleiter</i>	Inner Conductor <i>Innenleiter</i>	Outer Conductor <i>Außenleiter</i>		
FMX058P102	standard	1,3 µm Au	0,8 µm Au	1,3 µm Au	0,2 µm Au	179BU, 196AU, 404U	FMX058S102
FMX058P101	low cost	0,2 µm Au	0,2 µm Au	0,2 µm Au	5 µm Sn	179BU, 196AU, 404U	FMX058S101
FMX058P202	standard	AuroPur	AuroPur	AuroPur	0,2 µm Au		FMX058S202
FMX058P201	low cost	AuroPur	AuroPur	AuroPur	5 µm Sn		FMX058S201

Other platings on request / *Andere Oberflächen auf Anfrage*  
Tools from page 94 onwards / *Werkzeuge ab Seite 94 ff.*

8 microinches = ≈ 0,2 µm  
30 microinches = ≈ 0,8 µm  
50 microinches = ≈ 1,3 µm  
200 microinches = ≈ 5 µm

### Dimensions

### Abmessungen

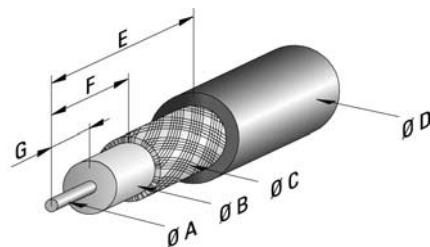
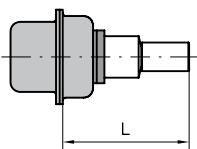

Order Number <i>Bestellnummer</i>	Ø A max.	Ø B max.	Ø C max.	Ø D max.	E	F	G	H approx. ca.	J	K	L
FMS016...	0,6 (0.024)	1,9 (0.075)	2,7 (0.106)	3,5 (0.138)	9,3 (0.366)	4,3 (0.169)	3,0 (0.118)	14,4 (0.567)	9,0 (0.354)	9,5 (0.374)	19,9 (0.783)
FMX058...	0,85 (0.033)	1,2 (0.047)	1,4 (0.055)	2,3 (0.091)	9,5 (0.374)	5,0 (0.197)	3,0 (0.118)	11,2 (0.441)	9,0 (0.354)	9,5 (0.374)	17 (0.669)

# Wiresplice

## Wiresplice

50 Ohm

50 Ohm

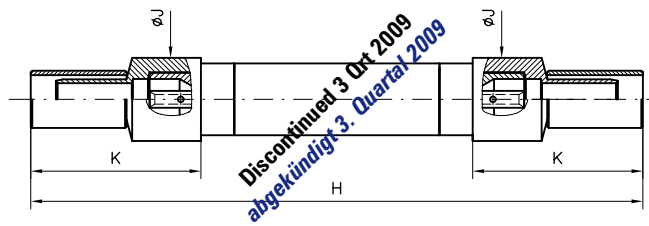

<b>Inner Conductor</b> <i>Innenleiter</i>	<b>Outer Conductor</b> <i>Außenleiter</i>
<b>Crimp termination</b> <i>Crimpen</i>	<b>Crimp termination</b> <i>Crimpen</i>

Order Number <i>Bestellnummer</i>	Type <i>Ausführung</i>	Platings / <i>Oberflächen</i>		Suitable Cables RG- <i>Verwendbare Kabel RG-</i>
		Inner Conductor <i>Innenleiter</i>	Outer Conductor <i>Außenleiter</i>	
FMS010-102	standard	1,3 µm Au	0,2 µm Au	174U, 188AU, 316U
FMS010-101	low cost	0,2 µm Au	5 µm Sn	
FMS030-102	standard	1,3 µm Au	0,2 µm Au	58CU, 141AU
FMS030-101	low cost	0,2 µm Au	5 µm Sn	

Other platings on request

*Andere Oberflächen auf Anfrage*

Tools from page 94 onwards

*Werkzeuge ab Seite 94 ff.*

8 microinches =  $\approx 0,2 \mu\text{m}$

30 microinches =  $\approx 0,8 \mu\text{m}$

50 microinches =  $\approx 1,3 \mu\text{m}$

200 microinches =  $\approx 5 \mu\text{m}$

## Dimensions

### Abmessungen

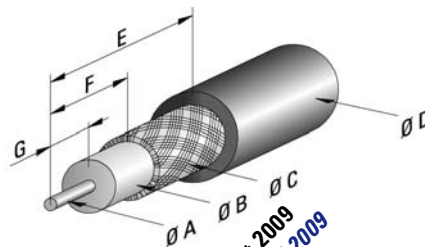

Order Number <i>Bestellnummer</i>	Ø A max.	Ø B max.	Ø C max.	E max.	F max.	G max.	H approx. ca.	J approx. ca.	K approx. ca.	
FMS010...	0,6 (0.024)	1,9 (0.075)	2,4 (0.094)	3,2 (0.126)	9,0 (0.354)	4,3 (0.169)	3,0 (0.118)	40,3 (1.587)	5,50 (0.217)	11,30 (0.445)
FMS030...	1,3 (0.051)	3,7 (0.146)	4,4 (0.173)	5,2 (0.205)	9,0 (0.354)	4,3 (0.169)	3,0 (0.118)	39,7 (1.563)	5,50 (0.217)	11,00 (0.433)



# FME Coaxial Contacts, 50 Ohm, Straight PCB Termination, 3 Pins

## FME Koaxialkontakte, 50 Ohm, gerader Leiterplattenanschluss, 3 Anschlüsse

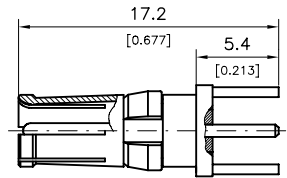
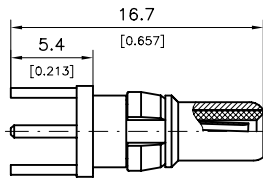

Order Number Plug <i>Bestellnummer Stecker</i>	Type <i>Ausführung</i>	Platings / <i>Oberflächen</i>				Order Number Receptacles <i>Bestellnummer Steckdose</i>
		Mating Area <i>Steckbereich</i>		Termination Area <i>Anschlussbereich</i>		
		Inner Conductor <i>Innenleiter</i>	Outer Conductor <i>Außenleiter</i>	Inner Conductor <i>Innenleiter</i>	Outer Conductor <i>Außenleiter</i>	
FME010P102	standard	1,3 μm Au	0,8 μm Au	1,3 μm Au	0,2 μm Au	FME010S102
FME010P101	low cost	0,2 μm Au	0,2 μm Au	0,2 μm Au	5 μm Sn	FME010S101
FME010P108		1,3 μm Au	0,8 μm Au	1,3 μm Au	5 μm Sn	FME010S108
FME010P202	standard	AuroPur	AuroPur	AuroPur	0,2 μm Au	FME010S202
FME010P201	low cost	AuroPur	AuroPur	AuroPur	5 μm Sn	FME010S201

Other platings on request / *Andere Oberflächen auf Anfrage*

8 microinches =  $\approx 0,2 \mu\text{m}$   
30 microinches =  $\approx 0,8 \mu\text{m}$

50 microinches =  $\approx 1,3 \mu\text{m}$   
200 microinches =  $\approx 5 \mu\text{m}$

### Dimensions of an Example Connector with Coaxial Contact FME010P... and Signal Contacts P1

#### Abmessungen am Beispiel Steckverbinder mit Koaxialkontakt FME010P... und Signalkontakten P1

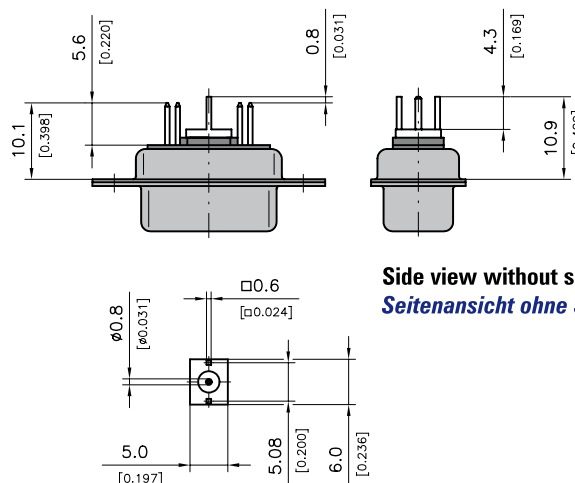

Side view without signal contacts!  
*Seitenansicht ohne Signalkontakte!*





# FME Coaxial Contacts, 50 Ohm, Right Angled PCB Termination, 3 Pins

## FME Koaxialkontakte, 50 Ohm, abgewinkelter Leiterplattenanschluss, 3 Anschlüsse

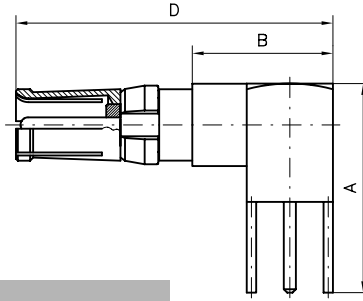
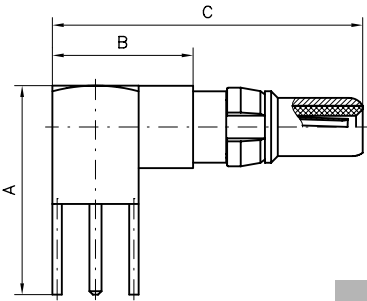

Order Number Plug <i>Bestellnummer Stecker</i>	Type <i>Ausführung</i>	Platings / <i>Oberflächen</i>				Order Number Receptacles <i>Bestellnummer Steckdose</i>
		Mating Area <i>Steckbereich</i>		Termination Area <i>Anschlussbereich</i>		
		Inner Conductor <i>Innenleiter</i>	Outer Conductor <i>Außenleiter</i>	Inner Conductor <i>Innenleiter</i>	Outer Conductor <i>Außenleiter</i>	
FME008P102	standard	1,3 μm Au	0,8 μm Au	1,3 μm Au	0,2 μm Au	FME008S102
FME008P101	low cost	0,2 μm Au	0,2 μm Au	0,2 μm Au	5 μm Sn	FME008S101
FME008P108		1,3 μm Au	0,8 μm Au	1,3 μm Au	5 μm Sn	FME008S108
FME008P202	standard	AuroPur	AuroPur	AuroPur	0,2 μm Au	FME008S202
FME008P201	low cost	AuroPur	AuroPur	AuroPur	5 μm Sn	FME008S201
FME020P102	standard	1,3 μm Au	0,8 μm Au	1,3 μm Au	0,2 μm Au	FME020S102
FME020P101	low cost	0,2 μm Au	0,2 μm Au	0,2 μm Au	5 μm Sn	FME020S101
FME020P108		1,3 μm Au	0,8 μm Au	1,3 μm Au	5 μm Sn	FME020S108

Other platings on request / *Andere Oberflächen auf Anfrage*

8 microinches =  $\approx 0,2 \mu\text{m}$

30 microinches =  $\approx 0,8 \mu\text{m}$

50 microinches =  $\approx 1,3 \mu\text{m}$

200 microinches =  $\approx 5 \mu\text{m}$

Type FME020... For use with D-Sub shell size 5 only.

*Typ FME020... Nur zur Verwendung in D-Sub Gehäusegröße 5.*

### Dimensions of an Example Connector with Coaxial Contacts FME008P.. or FME020P.. and Signal Contacts P5

#### Abmessungen am Beispiel Steckverbinder mit Koaxialkontakten FME008P.. oder FME020P.. und Signalkontakten P5

Order Number <i>Bestellnummer</i>	A	B	C	D
FME008...	13,8 (0.543)	9,3 (0.366)	20,7 (0.815)	21,2 (0.835)
FME020...	16,8 (0.661)	11,8 (0.465)	23,2 (0.913)	23,7 (0.933)

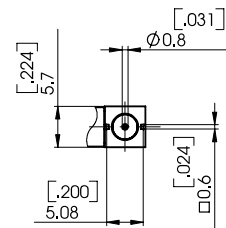

Shell sizes 1 - 4  
*Gehäusegrößen 1 - 4*

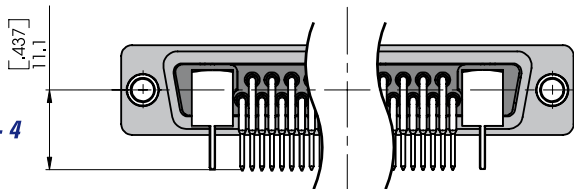

Connector with coaxial contacts FME008P.. and signal contacts P5  
*Steckverbinder mit Koaxialkontakten FME008P.. und Signalkontakten P5*

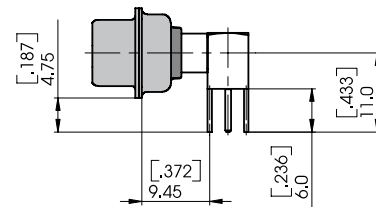

Shell size 5  
*Gehäusegröße 5*

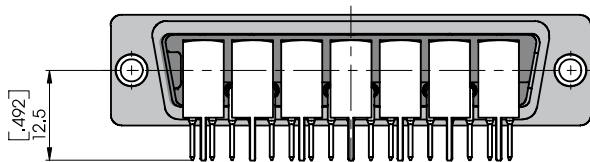

Connector with coaxial contacts FME020P.. and signal contacts P5  
*Steckverbinder mit Koaxialkontakten FME020P.. und Signalkontakten P5*

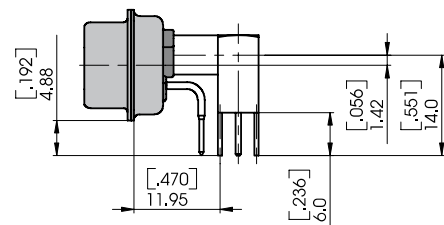



# FME Coaxial Contacts, 50 Ohm, Right Angled PCB Termination, 5 Pins

## FME Koaxialkontakte, 50 Ohm, abgewinkelter Leiterplattenanschluss, 5 Anschlüsse

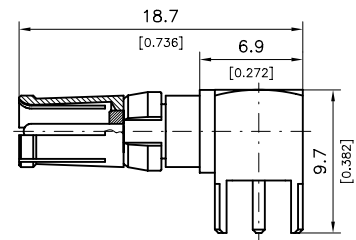
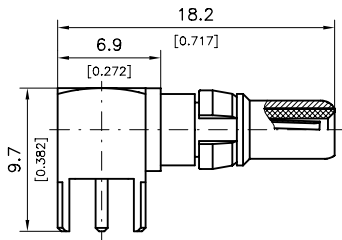

Order Number Plug <i>Bestellnummer Stecker</i>	Type <i>Ausführung</i>	Platings / <i>Oberflächen</i>				Order Number Receptacles <i>Bestellnummer Steckdose</i>
		Mating Area <i>Steckbereich</i>		Termination Area <i>Anschlussbereich</i>		
		Inner Conductor <i>Innenleiter</i>	Outer Conductor <i>Außenleiter</i>	Inner Conductor <i>Innenleiter</i>	Outer Conductor <i>Außenleiter</i>	
FME009P102	standard	1,3 μm Au	0,8 μm Au	1,3 μm Au	0,2 μm Au	FME009S102
FME009P101	low cost	0,2 μm Au	0,2 μm Au	0,2 μm Au	5 μm Sn	FME009S101
FME009P108		1,3 μm Au	0,8 μm Au	1,3 μm Au	5 μm Sn	FME009S108
FME009P202	standard	AuroPur	AuroPur	AuroPur	0,2 μm Au	FME009S202
FME009P201	low cost	AuroPur	AuroPur	AuroPur	5 μm Sn	FME009S201

Other platings on request / *Andere Oberflächen auf Anfrage*

8 microinches =  $\approx 0,2 \mu\text{m}$   
30 microinches =  $\approx 0,8 \mu\text{m}$

50 microinches =  $\approx 1,3 \mu\text{m}$   
200 microinches =  $\approx 5 \mu\text{m}$

### Dimensions of an Example Connector with Coaxial Contact FME009P... and Signal Contacts P45

#### Abmessungen am Beispiel Steckverbinder mit Koaxialkontakt FME009P... und Signalkontakten P45

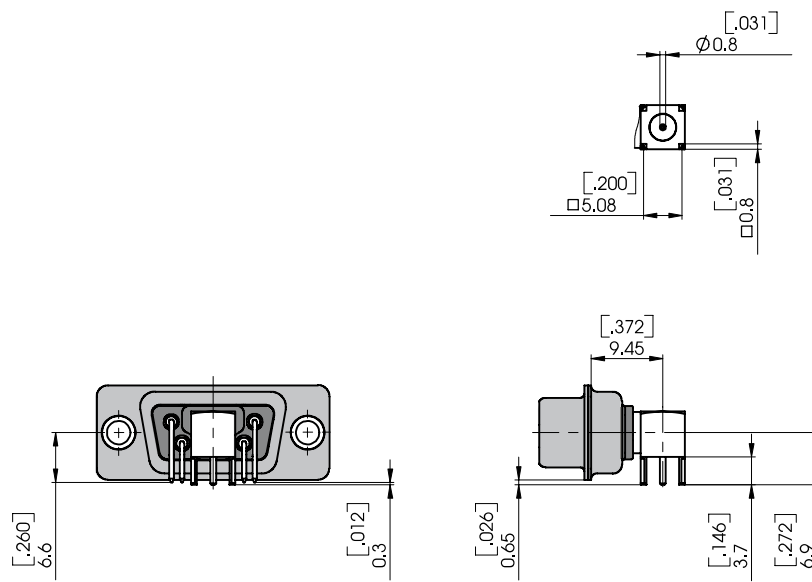

Side view without signal contacts!  
*Seitenansicht ohne Signalkontakte!*



## FME Coaxial Contacts, 75 Ohm, Straight PCB Termination, 3 Pins

### FME Koaxialkontakte, 75 Ohm, gerader Leiterplattenanschluss, 3 Anschlüsse

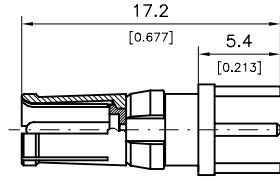
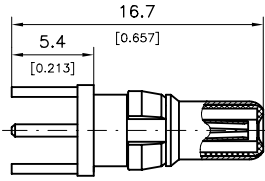

Order Number Plug <i>Bestellnummer Stecker</i>	Type <i>Ausführung</i>	Platings / <i>Oberflächen</i>				Order Number Receptacles <i>Bestellnummer Steckdose</i>
		Mating Area <i>Steckbereich</i>		Termination Area <i>Anschlussbereich</i>		
		Inner Conductor <i>Innenleiter</i>	Outer Conductor <i>Außenleiter</i>	Inner Conductor <i>Innenleiter</i>	Outer Conductor <i>Außenleiter</i>	
FME005P102	standard	1,3 $\mu\text{m}$ Au	0,8 $\mu\text{m}$ Au	1,3 $\mu\text{m}$ Au	0,2 $\mu\text{m}$ Au	FME005S102
FME005P101	low cost	0,2 $\mu\text{m}$ Au	0,2 $\mu\text{m}$ Au	0,2 $\mu\text{m}$ Au	5 $\mu\text{m}$ Sn	FME005S101
FME005P108		1,3 $\mu\text{m}$ Au	0,8 $\mu\text{m}$ Au	1,3 $\mu\text{m}$ Au	5 $\mu\text{m}$ Sn	FME005S108
FME005P202	standard	AuroPur	AuroPur	AuroPur	0,2 $\mu\text{m}$ Au	FME005S202
FME005P201	low cost	AuroPur	AuroPur	AuroPur	5 $\mu\text{m}$ Sn	FME005S201

Other platings on request / *Andere Oberflächen auf Anfrage*

8 microinches =  $\approx 0,2 \mu\text{m}$   
30 microinches =  $\approx 0,8 \mu\text{m}$

50 microinches =  $\approx 1,3 \mu\text{m}$   
200 microinches =  $\approx 5 \mu\text{m}$

## Dimensions of an Example Connector with Coaxial Contacts FME005P.. and Signal Contacts P1

### Abmessungen am Beispiel Steckverbinder mit Koaxialkontakt FME005P.. und Signalkontakten P1

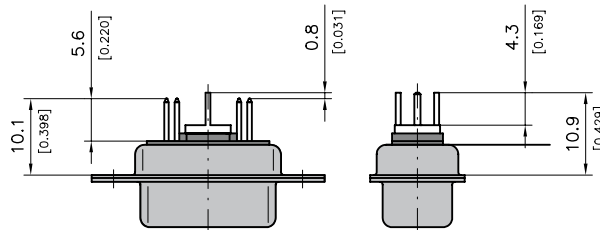

Side view without signal contacts!  
*Seitenansicht ohne Signalkontakte!*

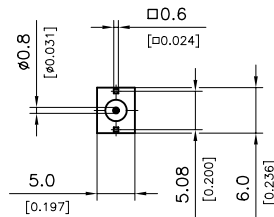



# FME Coaxial Contacts, 75 Ohm, Right Angled PCB Termination, 3 Pins

## FME Koaxialkontakte, 75 Ohm, abgewinkelter Leiterplattenanschluss, 3 Anschlüsse

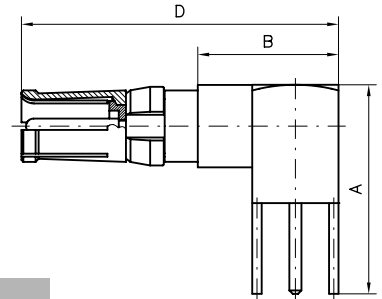
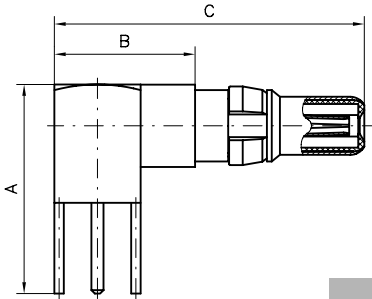

Order Number Plug <i>Bestellnummer Stecker</i>	Type <i>Ausführung</i>	Platings / <i>Oberflächen</i>				Order Number Receptacles <i>Bestellnummer Steckdose</i>
		Mating Area <i>Steckbereich</i>		Termination Area <i>Anschlussbereich</i>		
		Inner Conductor <i>Innenleiter</i>	Outer Conductor <i>Außenleiter</i>	Inner Conductor <i>Innenleiter</i>	Outer Conductor <i>Außenleiter</i>	
FME001P102	standard	1,3 μm Au	0,8 μm Au	1,3 μm Au	0,2 μm Au	FME001S102
FME001P101	low cost	0,2 μm Au	0,2 μm Au	0,2 μm Au	5 μm Sn	FME001S101
FME001P108		1,3 μm Au	0,8 μm Au	1,3 μm Au	5 μm Sn	FME001S108
FME001P202	standard	AuroPur	AuroPur	AuroPur	0,2 μm Au	FME001S202
FME001P201	low cost	AuroPur	AuroPur	AuroPur	5 μm Sn	FME001S201
FME018P102	standard	1,3 μm Au	0,8 μm Au	1,3 μm Au	0,2 μm Au	FME018S102
FME018P101	low cost	0,2 μm Au	0,2 μm Au	0,2 μm Au	5 μm Sn	FME018S101
FME018P108		1,3 μm Au	0,8 μm Au	1,3 μm Au	5 μm Sn	FME018S108

Other platings on request / *Andere Oberflächen auf Anfrage*

8 microinches =  $\approx 0,2 \mu\text{m}$

30 microinches =  $\approx 0,8 \mu\text{m}$

50 microinches =  $\approx 1,3 \mu\text{m}$

200 microinches =  $\approx 5 \mu\text{m}$

Type FME018... for use with D-Sub shell size 5 only.

*Typ FME018... nur zur Verwendung in D-Sub Gehäusegröße 5.*

### Dimensions of an Example Connector with Coaxial Contacts FME001P... (Shell Sizes 1 - 4) or FME018P... and Signal Contacts P5

#### Abmessungen am Beispiel Steckverbinder mit Koaxialkontakten FME001P... (Gehäusegröße 1 - 4) oder FME018P... und Signalkontakten P5

Order Number <i>Bestellnummer</i>	A	B	C	D
FME001...	13,8 (0.543)	9,3 (0.366)	20,7 (0.815)	21,2 (0.835)
FME018...	16,8 (0.661)	11,8 (0.465)	23,2 (0.913)	23,7 (0.933)

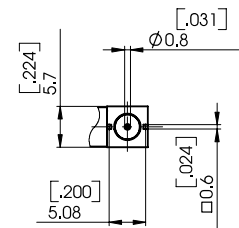

Shell sizes 1 - 4  
*Gehäusegrößen 1 - 4*

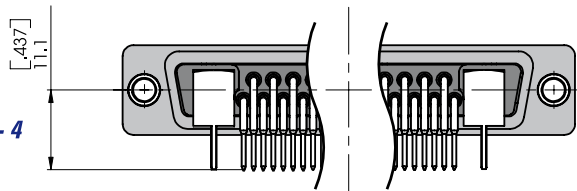

Connector with coaxial contacts FME001P... and signal contacts P5  
*Steckverbinder mit Koaxialkontakten FME001P... und Signalkontakten P5*

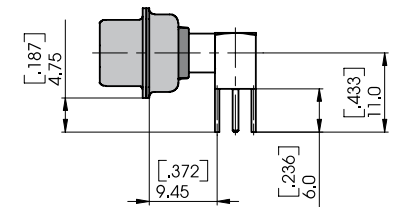

Shell size 5  
*Gehäusegröße 5*

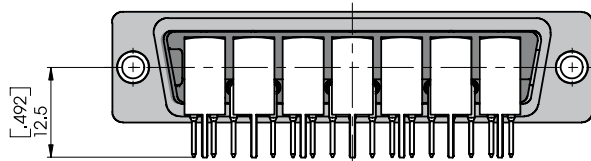

Connector with coaxial contacts FME018P... and signal contacts P5  
*Steckverbinder mit Koaxialkontakten FME018P... und Signalkontakten P5*

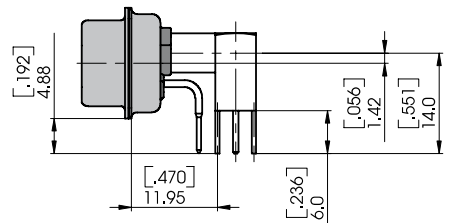



# FME Coaxial Contacts, 75 Ohm, Right Angled PCB Termination, 5 Pins

## FME Koaxialkontakte, 75 Ohm, abgewinkelter Leiterplattenanschluss, 5 Anschlüsse

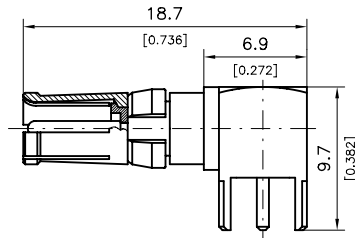
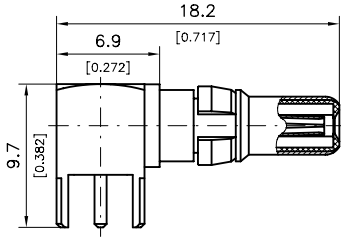

### Platings / Oberflächen

Order Number Plug <i>Bestellnummer Stecker</i>	Type <i>Ausführung</i>	Mating Area <i>Steckbereich</i>		Termination Area <i>Anschlussbereich</i>		Order Number Receptacles <i>Bestellnummer Steckdose</i>
		Inner Conductor <i>Innenleiter</i>	Outer Conductor <i>Außenleiter</i>	Inner Conductor <i>Innenleiter</i>	Outer Conductor <i>Außenleiter</i>	
FME002P102	standard	1,3 μm Au	0,8 μm Au	1,3 μm Au	0,2 μm Au	FME002S102
FME002P101	low cost	0,2 μm Au	0,2 μm Au	0,2 μm Au	5 μm Sn	FME002S101
FME002P108		1,3 μm Au	0,8 μm Au	1,3 μm Au	5 μm Sn	FME002S108
FME002P202	standard	AuroPur	AuroPur	AuroPur	0,2 μm Au	FME002S202
FME002P201	low cost	AuroPur	AuroPur	AuroPur	5 μm Sn	FME002S201

Other platings on request / *Andere Oberflächen auf Anfrage*

8 microinches =  $\approx 0,2 \mu\text{m}$   
30 microinches =  $\approx 0,8 \mu\text{m}$

50 microinches =  $\approx 1,3 \mu\text{m}$   
200 microinches =  $\approx 5 \mu\text{m}$

### Dimensions of an Example Connector with Coaxial Contact FME002P... and Signal Contacts P45

#### Abmessungen am Beispiel Steckverbinder mit Koaxialkontakt FME002P... und Signalkontakten P45

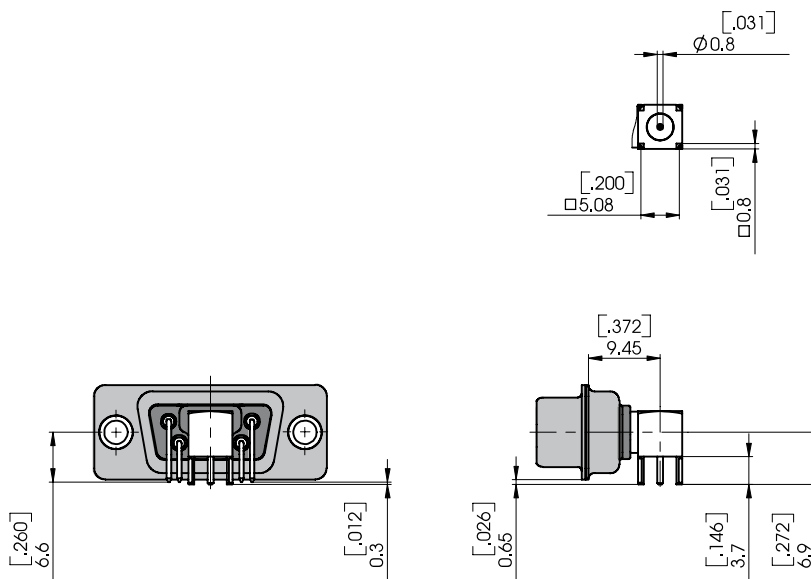

Side view without signal contacts!  
*Seitenansicht ohne Signalkontakte!*

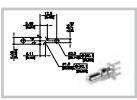

# PCB Hole Pattern for Connectors with Straight PCB Terminations

## Leiterplattenlochbild für Steckverbinder mit geradem Leiterplattenanschluss

All PCB hole patterns apply to male connectors with straight PCB contacts (signal contacts P1) and the coaxial contacts **FME010P...** or **FME005P...** (when using female connectors the hole pattern must be mirrored on the Y-axis).

Measurements without tolerances are in accordance with DIN ISO 2768 m.

Alle Lochbilder gelten für Stiftsteckverbinder mit geradem Leiterplattenanschluss (Signalkontakte P1) und eingebauten Koaxialkontakten **FME010P...** bzw. **FME005P...** (bei Verwendung von Buchsensteckverbindern muss das Lochbild an der Y-Achse gespiegelt werden).

Maße ohne Toleranzangabe nach DIN ISO 2768 m.

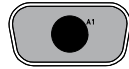

F1W1

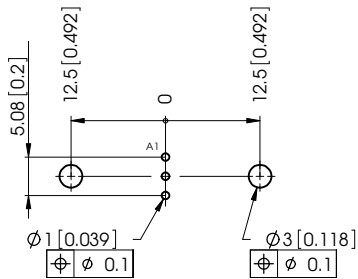

F2W2...C / FM2W2

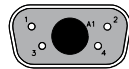
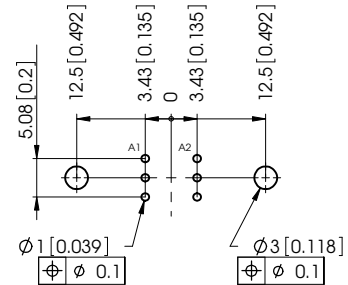

FM5W1

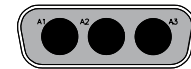
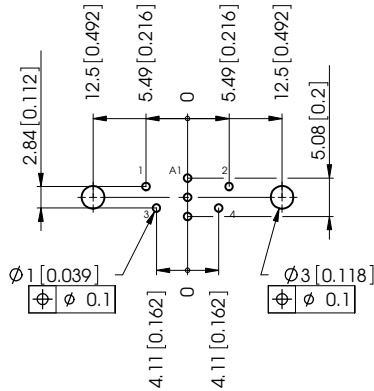

FM3W3 / F3W3...C

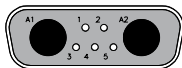
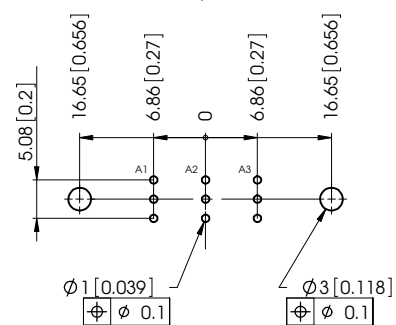

FM7W2

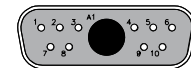
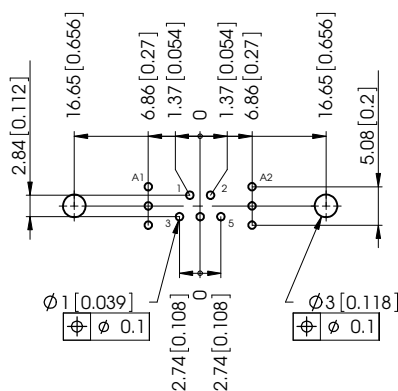

FM11W1

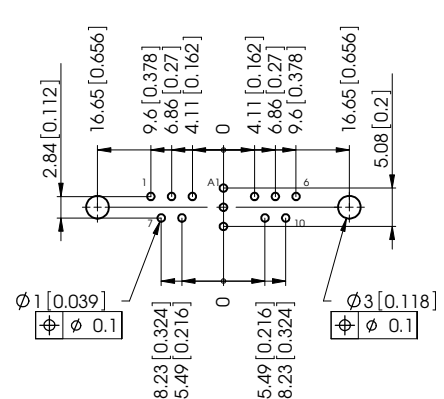

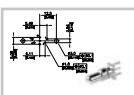

# PCB Hole Pattern for Connectors with Straight PCB Terminations

## Leiterplattenlochbild für Steckverbinder mit geradem Leiterplattenanschluss

All PCB hole patterns apply to male connectors with straight PCB contacts (signal contacts P1) and the coaxial contacts **FME010P...** or **FME005P...** (when using female connectors the hole pattern must be mirrored on the Y-axis).

Measurements without tolerances are in accordance with DIN ISO 2768 m.

Alle Lochbilder gelten für Stiftsteckverbinder mit geradem Leiterplattenanschluss (Signalkontakte P1) und eingebauten Koaxialkontakten **FME010P...** bzw. **FME005P...** (bei Verwendung von Buchsensteckverbindern muss das Lochbild an der Y-Achse gespiegelt werden).

Maße ohne Toleranzangabe nach DIN ISO 2768 m.

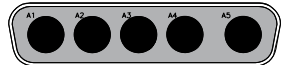

FM5W5

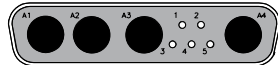
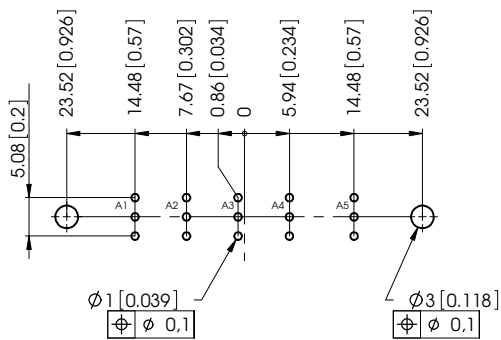

FM9W4

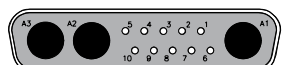
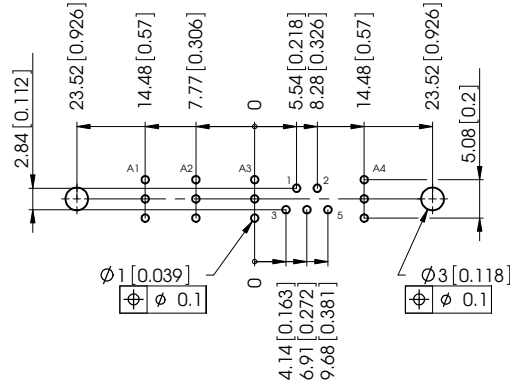

FM13W3

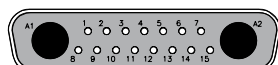
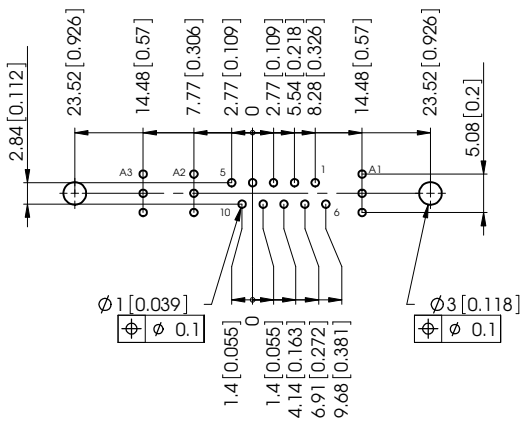

FM17W2

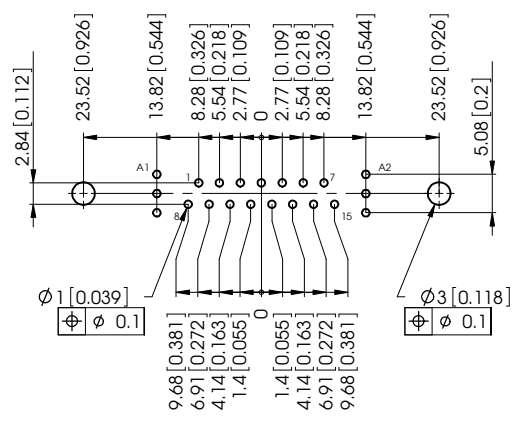

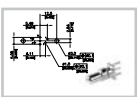

# PCB Hole Pattern for Connectors with Straight PCB Terminations

## Leiterplattenlochbild für Steckverbinder mit geradem Leiterplattenanschluss

All PCB hole patterns apply to male connectors with straight PCB contacts (signal contacts P1) and the coaxial contacts **FME010P...** or **FME005P...** (when using female connectors the hole pattern must be mirrored on the Y-axis).

Measurements without tolerances are in accordance with DIN ISO 2768 m.

Alle Lochbilder gelten für Stiftsteckverbinder mit geradem Leiterplattenanschluss (Signalkontakte P1) und eingebauten Koaxialkontakten **FME010P...** bzw. **FME005P...** (bei Verwendung von Buchsensteckverbindern muss das Lochbild an der Y-Achse gespiegelt werden).

Maße ohne Toleranzangabe nach DIN ISO 2768 m.

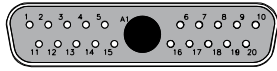

FM21W1

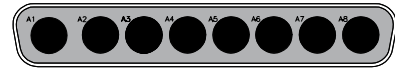
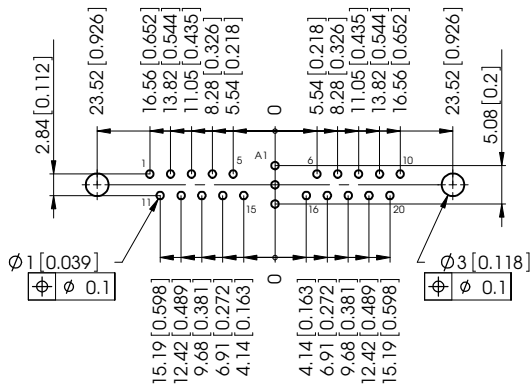

FM8W8

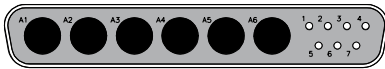
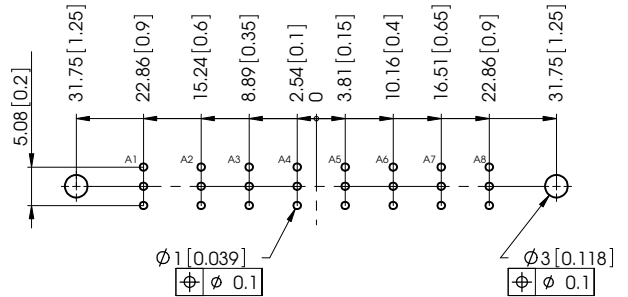

FM13W6

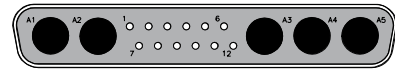
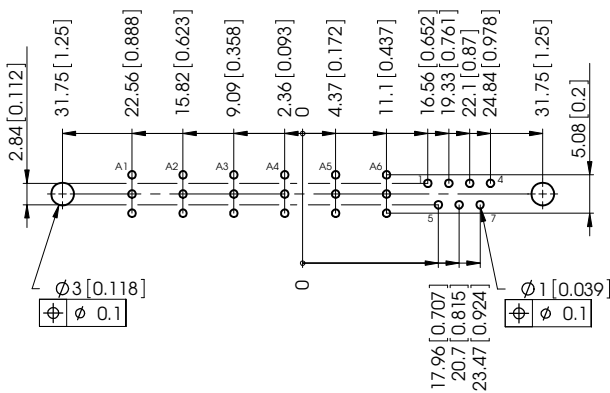

FM17W5

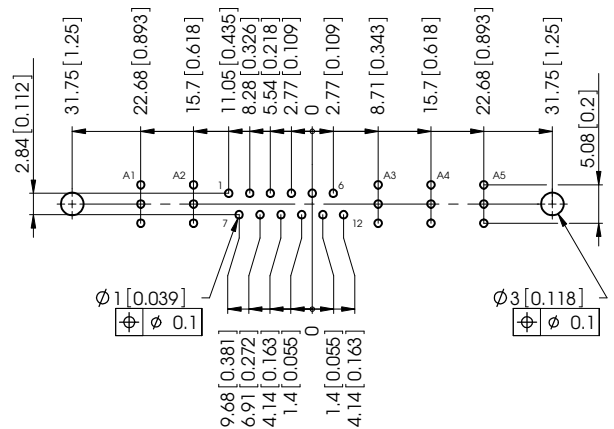



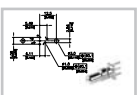

# PCB Hole Pattern for Connectors with Straight PCB Terminations

## Leiterplattenlochbild für Steckverbinder mit geradem Leiterplattenanschluss

All PCB hole patterns apply to male connectors with straight PCB contacts (signal contacts P1) and the coaxial contacts **FME010P...** or **FME005P...** (when using female connectors the hole pattern must be mirrored on the Y-axis).

Measurements without tolerances are in accordance with DIN ISO 2768 m.

Alle Lochbilder gelten für Stiftsteckverbinder mit geradem Leiterplattenanschluss (Signalkontakte P1) und eingebauten Koaxialkontakten **FME010P...** bzw. **FME005P...** (bei Verwendung von Buchsensteckverbindern muss das Lochbild an der Y-Achse gespiegelt werden).

Maße ohne Toleranzangabe nach DIN ISO 2768 m.

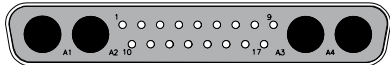

FM21WA4

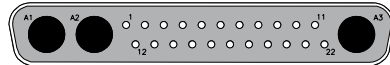
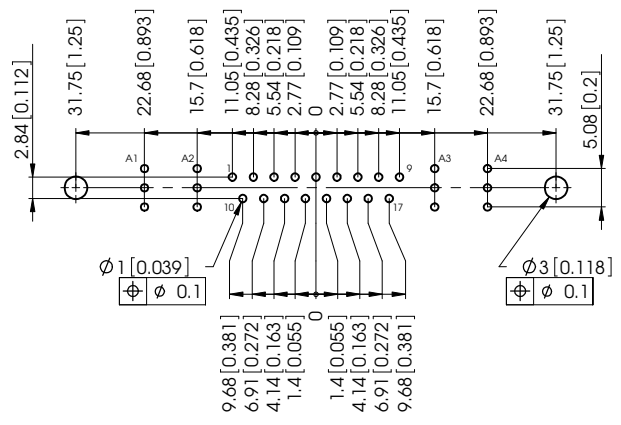

FM25W3

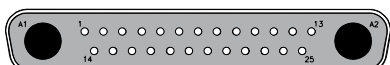
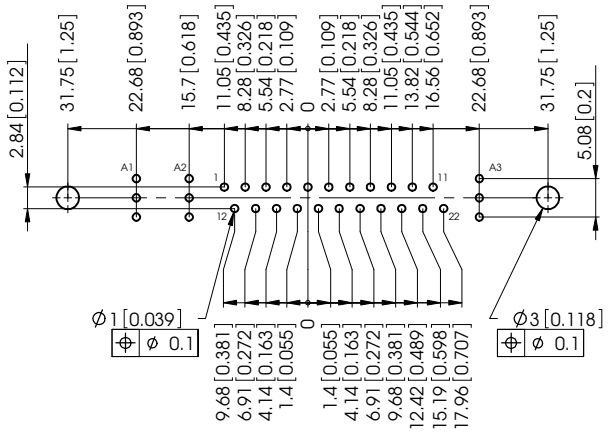

FM27W2

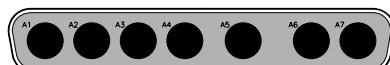
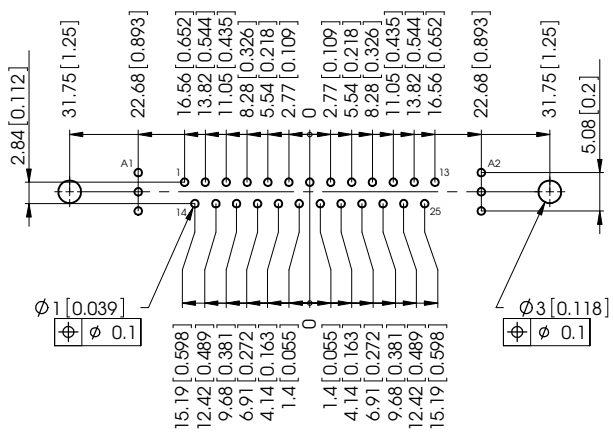

F7W7

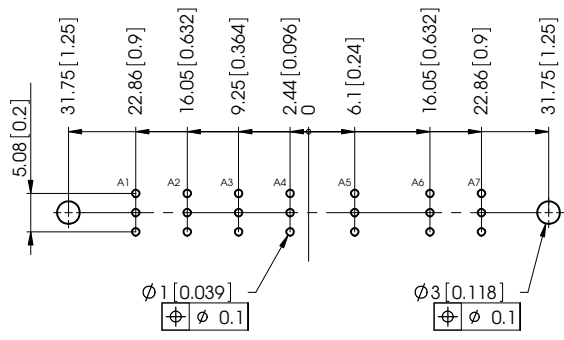

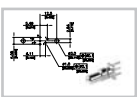

# PCB Hole Pattern for Connectors with Straight PCB Terminations

## Leiterplattenlochbild für Steckverbinder mit geradem Leiterplattenanschluss

All PCB hole patterns apply to male connectors with straight PCB contacts (signal contacts P1) and the coaxial contacts **FME010P...** or **FME005P...** (when using female connectors the hole pattern must be mirrored on the Y-axis).

Measurements without tolerances are in accordance with DIN ISO 2768 m.

Alle Lochbilder gelten für Stiftsteckverbinder mit geradem Leiterplattenanschluss (Signalkontakte P1) und eingebauten Koaxialkontakten **FME010P...** bzw. **FME005P...** (bei Verwendung von Buchsensteckverbindern muss das Lochbild an der Y-Achse gespiegelt werden).

Maße ohne Toleranzangabe nach DIN ISO 2768 m.

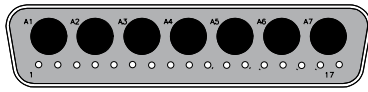

FM24W4

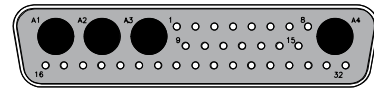
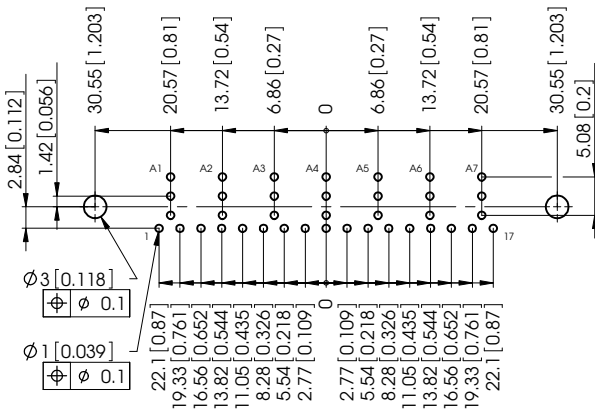

FM36W4

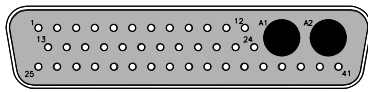
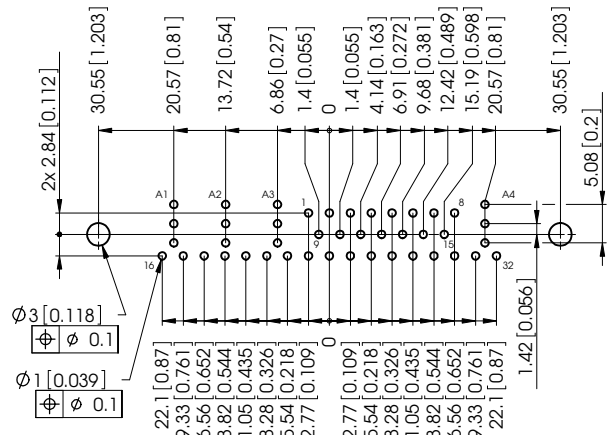

FM43W2

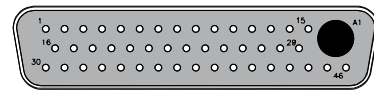
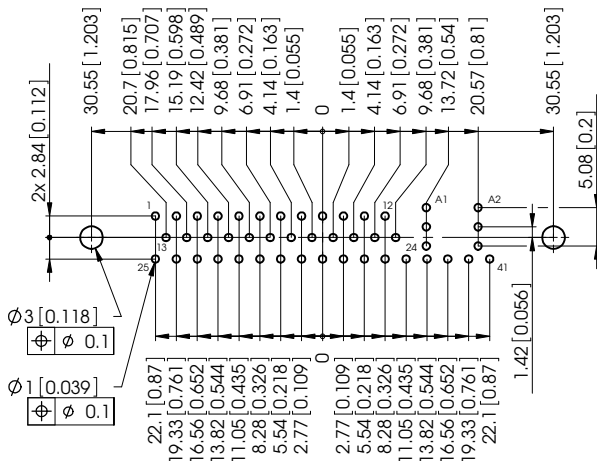

FM47W1

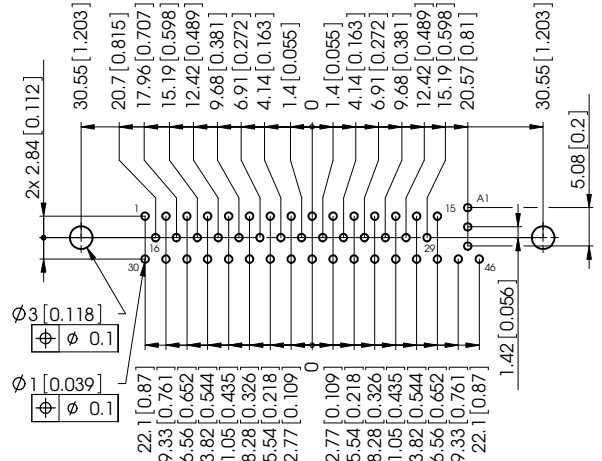

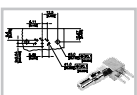

# PCB Hole Pattern for Connectors with Right Angled PCB Terminations

## Leiterplattenlochbild für Steckverbinder mit abgewinkeltm Leiterplattenanschluss

All PCB hole patterns apply to male connectors with right angle PCB contacts (signal contacts P5) and the metal bracket F1080-13B as well as the coaxial contacts **FME008P...** or **FME001P...** (When using female connectors the hole pattern must be mirrored on the Y-axis).

Measurements without tolerances are in accordance with DIN ISO 2768 m.

Alle Lochbilder gelten für Stiftsteckverbinder mit abgewinkeltm Leiterplattenanschluss (Signalkontakte P5) und Metallwinkel F1080-13B sowie eingebauten Koaxialkontakten **FME008P...** bzw. **FME001P...** (bei Verwendung von Buchsensteckverbindern muss das Lochbild an der Y-Achse gespiegelt werden).

Maße ohne Toleranzangabe nach DIN ISO 2768 m.

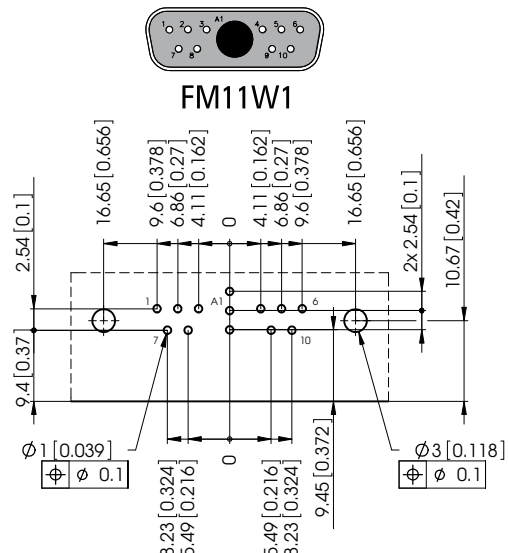
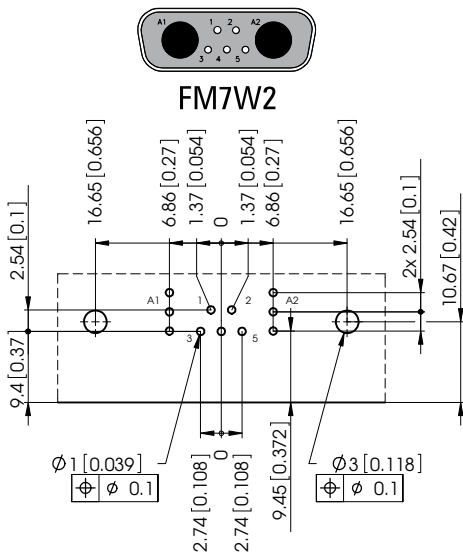
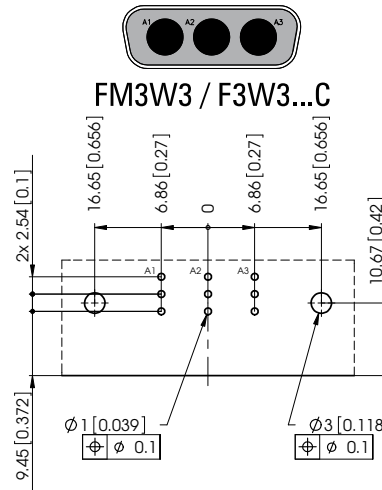
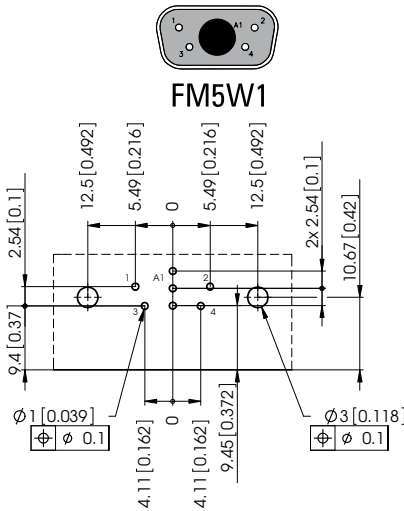
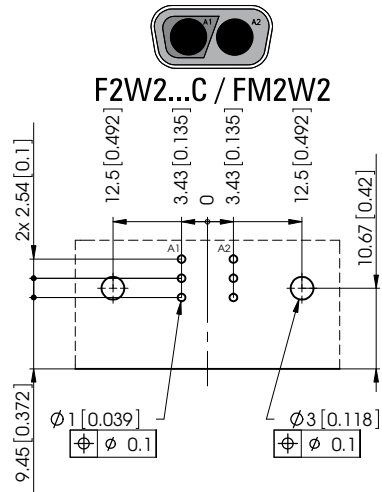
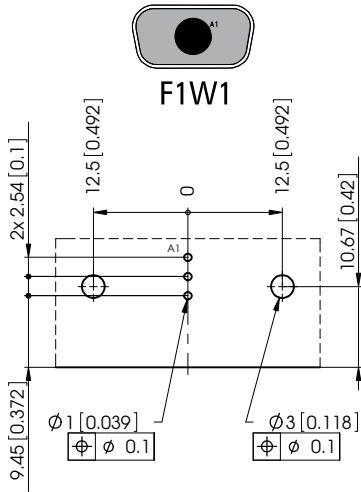

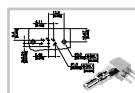

# PCB Hole Pattern for Connectors with Right Angled PCB Terminations

## Leiterplattenlochbild für Steckverbinder mit abgewinkelttem Leiterplattenanschluss

All PCB hole patterns apply to male connectors with right angle PCB contacts (signal contacts P5) and the metal bracket F1080-13B as well as the coaxial contacts **FME008P..** or **FME001P..** (When using female connectors the hole pattern must be mirrored on the Y-axis). 

Measurements without tolerances are in accordance with DIN ISO 2768 m.

Alle Lochbilder gelten für Stiftsteckverbinder mit abgewinkelttem Leiterplattenanschluss (Signalkontakte P5) und Metallwinkel F1080-13B sowie eingebauten Koaxialkontakten **FME008P..** bzw. **FME001P..** (bei Verwendung von Buchsensteckverbindern muss das Lochbild an der Y-Achse gespiegelt werden). 

Maße ohne Toleranzangabe nach DIN ISO 2768 m.

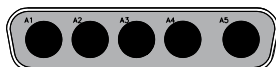

FM5W5

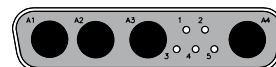
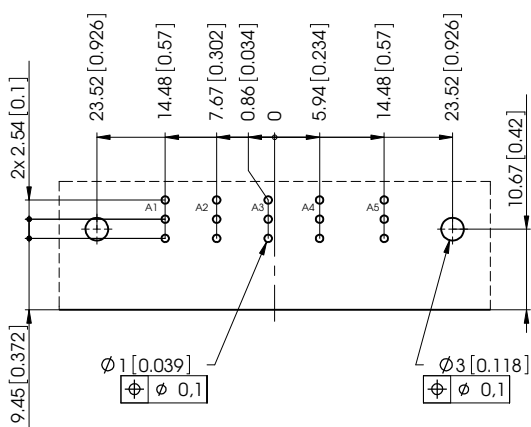

FM9W4

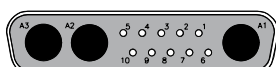
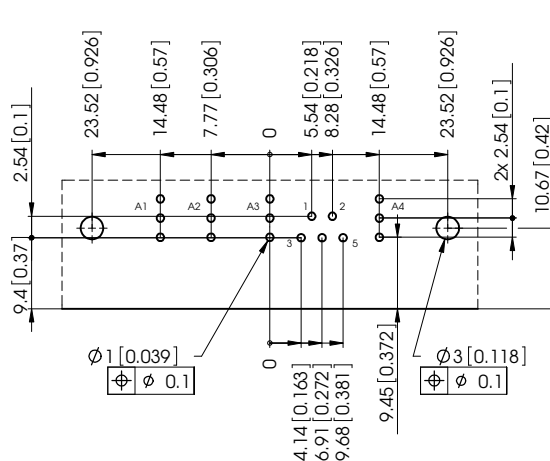

FM13W3

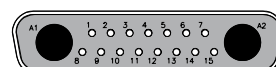
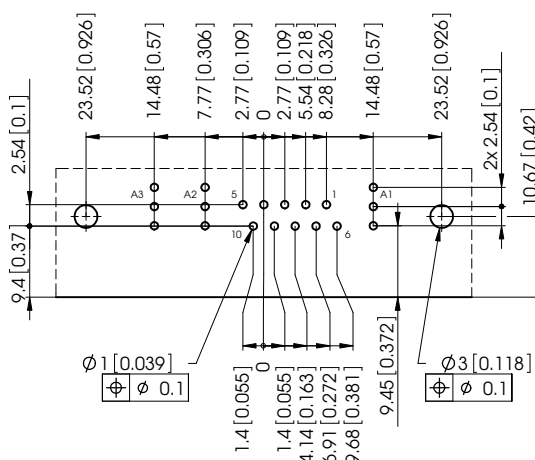

FM17W2

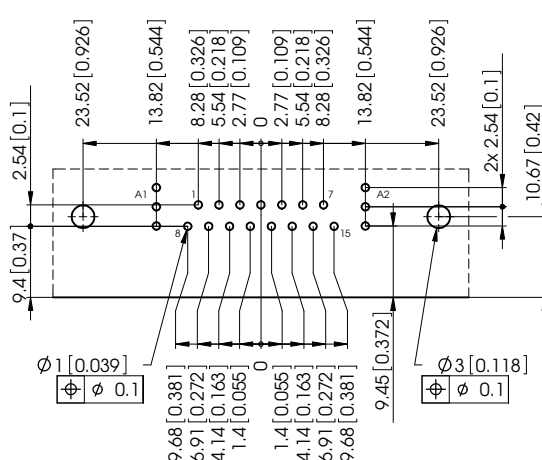

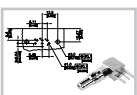

# PCB Hole Pattern for Connectors with Right Angled PCB Terminations

## Leiterplattenlochbild für Steckverbinder mit abgewinkelttem Leiterplattenanschluss

All PCB hole patterns apply to male connectors with right angle PCB contacts (signal contacts P5) and the metal bracket F1080-13B as well as the coaxial contacts **FME008P...** or **FME001P...** (When using female connectors the hole pattern must be mirrored on the Y-axis).

Measurements without tolerances are in accordance with DIN ISO 2768 m.

Alle Lochbilder gelten für Stiftsteckverbinder mit abgewinkelttem Leiterplattenanschluss (Signalkontakte P5) und Metallwinkel F1080-13B sowie eingebauten Koaxialkontakten **FME008P...** bzw. **FME001P...** (bei Verwendung von Buchsensteckverbindern muss das Lochbild an der Y-Achse gespiegelt werden).

Maße ohne Toleranzangabe nach DIN ISO 2768 m.

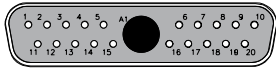

FM21W1

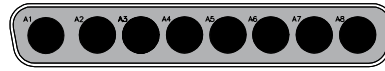
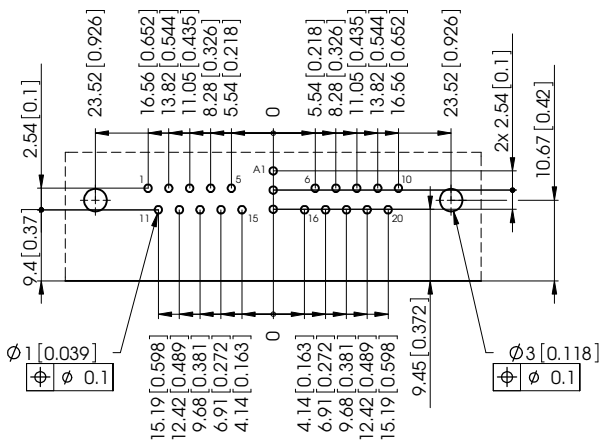

FM8W8

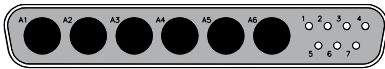
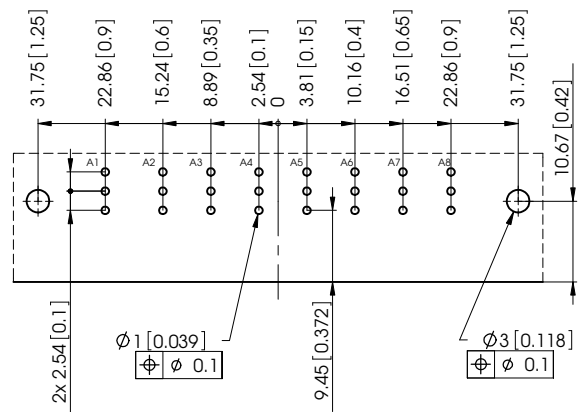

FM13W6

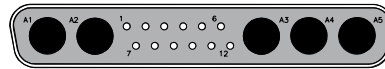
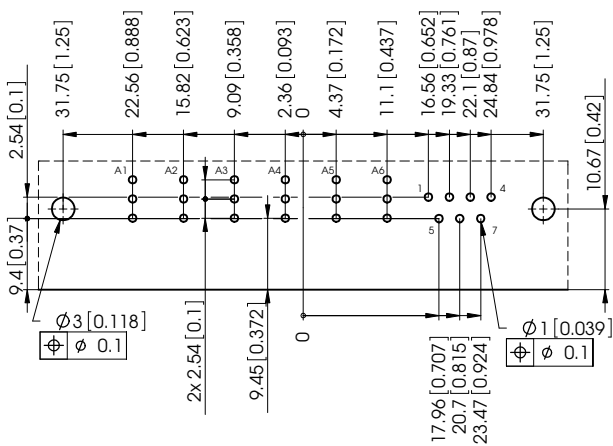

FM17W5

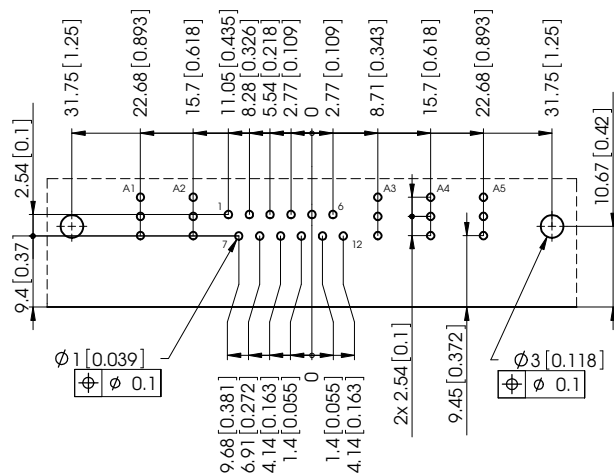

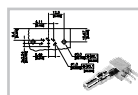

# PCB Hole Pattern for Connectors with Right Angled PCB Terminations

## Leiterplattenlochbild für Steckverbinder mit abgewinkeltm Leiterplattenanschluss

All PCB hole patterns apply to male connectors with right angle PCB contacts (signal contacts P5) and the metal bracket F1080-13B as well as the coaxial contacts **FME008P..** or **FME001P..** (When using female connectors the hole pattern must be mirrored on the Y-axis). Measurements without tolerances are in accordance with DIN ISO 2768 m.

*Alle Lochbilder gelten für Stiftsteckverbinder mit abgewinkeltm Leiterplattenanschluss (Signalkontakte P5) und Metallwinkel F1080-13B sowie eingebauten Koaxialkontakten FME008P.. bzw. FME001P.. (bei Verwendung von Buchsensteckverbindern muss das Lochbild an der Y-Achse gespiegelt werden).* Maße ohne Toleranzangabe nach DIN ISO 2768 m.

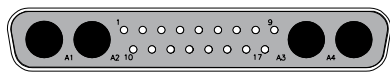

FM21WA4

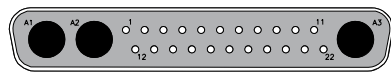
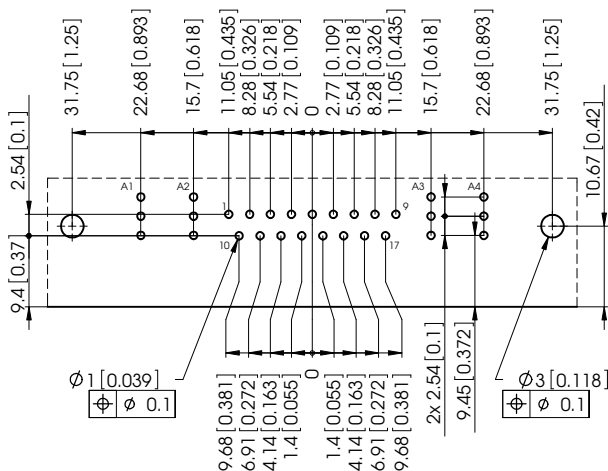

FM25W3

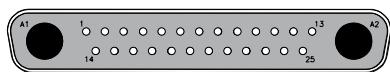
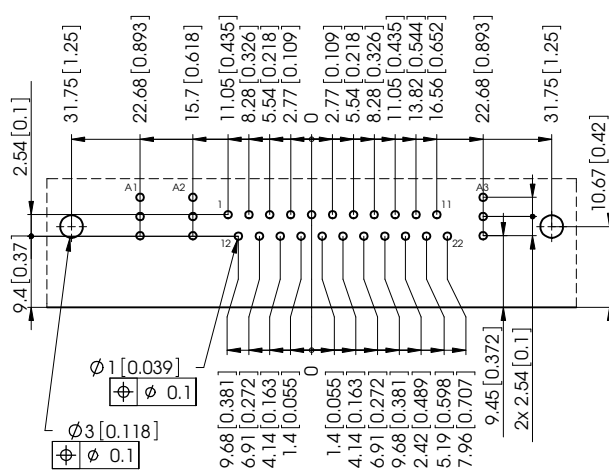

FM27W2

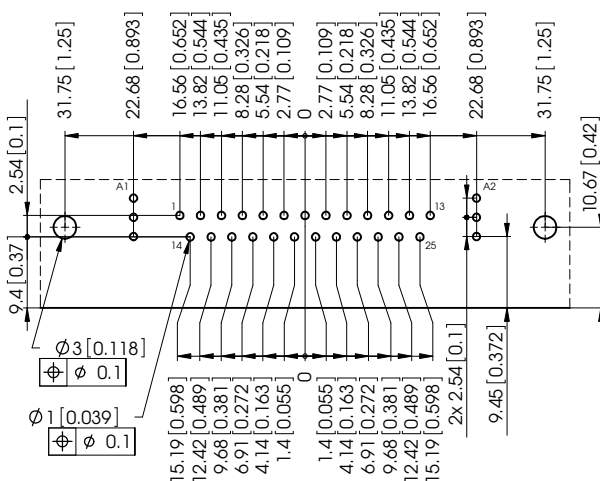

F7W7

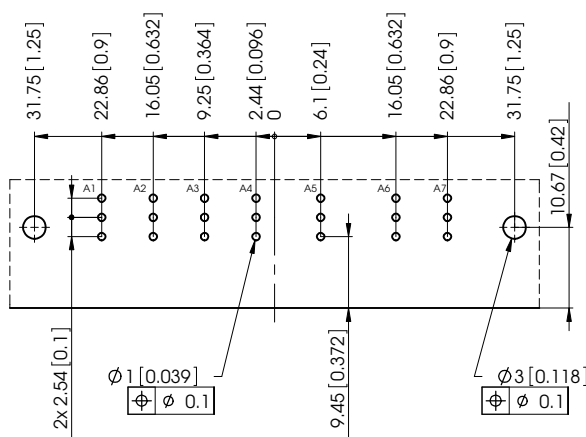

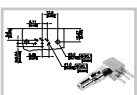

# PCB Hole Pattern for Connectors with Right Angled PCB Terminations

## Leiterplattenlochbild für Steckverbinder mit abgewinkeltm Leiterplattenanschluss

All PCB hole patterns apply to male connectors with right angle PCB contacts (signal contacts P5) and the metal bracket F1080-23 as well as the coaxial contacts FME018P... or FME020P... (When using female connectors the hole pattern must be mirrored on the Y-axis).   
 Measurements without tolerances are in accordance with DIN ISO 2768 m.

Alle Lochbilder gelten für Stiftsteckverbinder mit abgewinkeltm Leiterplattenanschluss (Signalkontakte P5) und Metallwinkel F1080-23 sowie eingebauten Koaxialkontakten FME018P... bzw. FME020P... (bei Verwendung von Buchsensteckverbindern muss das Lochbild an der Y-Achse gespiegelt werden).   
 Maße ohne Toleranzangabe nach DIN ISO 2768 m.

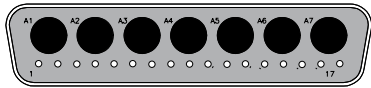

FM24W7

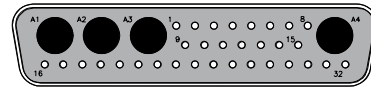

FM36W4

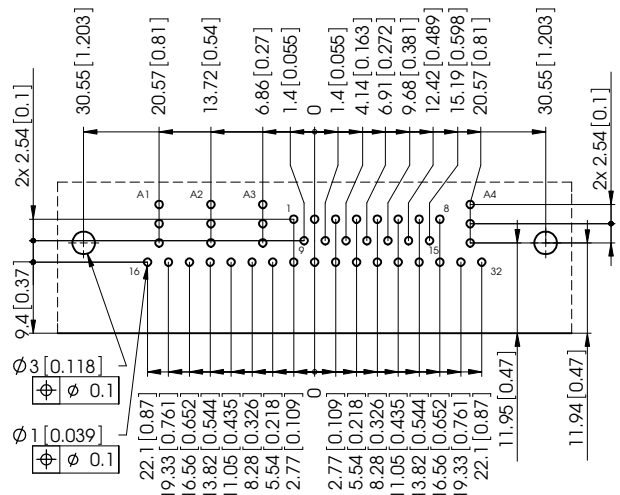
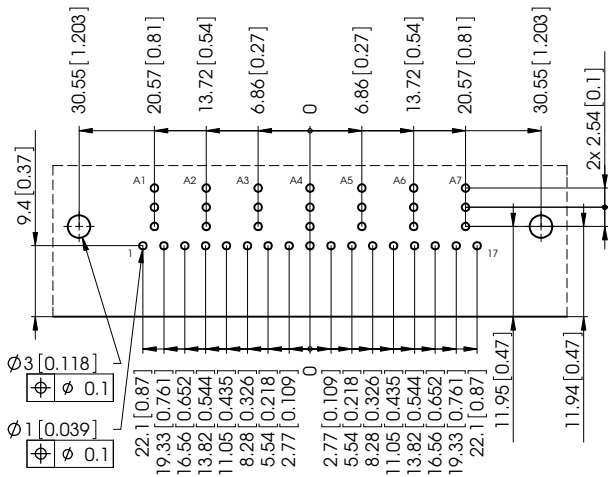

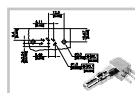

# PCB Hole Pattern for Connectors with Right Angled PCB Terminations

## Leiterplattenlochbild für Steckverbinder mit abgewinkelttem Leiterplattenanschluss

All PCB hole patterns apply to male connectors with right angle PCB contacts (signal contacts P5) and the metal bracket F1080-23 as well as the coaxial contacts **FME018P...** or **FME020P...** (When using female connectors the hole pattern must be mirrored on the Y-axis). 

Measurements without tolerances are in accordance with DIN ISO 2768 m.  
*Alle Lochbilder gelten für Stiftsteckverbinder mit abgewinkelttem Leiterplattenanschluss (Signalkontakte P5) und Metallwinkel F1080-23 sowie eingebauten Koaxialkontakten **FME018P...** bzw. **FME020P...** (bei Verwendung von Buchsensteckverbindern muss das Lochbild an der Y-Achse gespiegelt werden).* 

Maße ohne Toleranzangabe nach DIN ISO 2768 m.

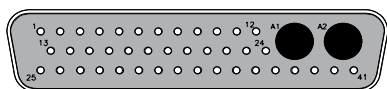

FM43W2

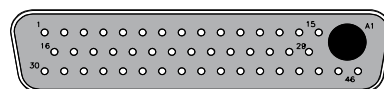
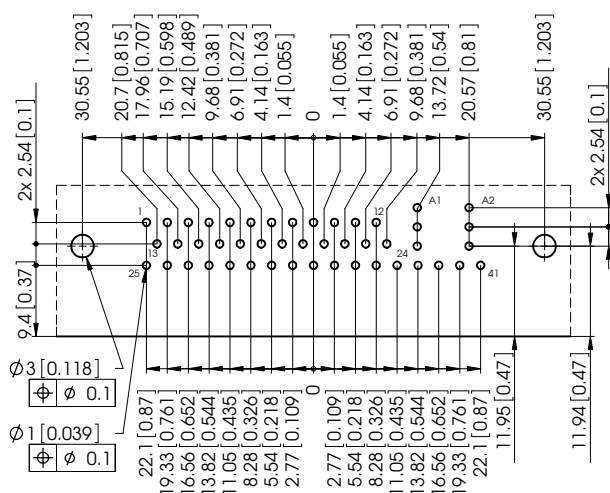

FM47W1

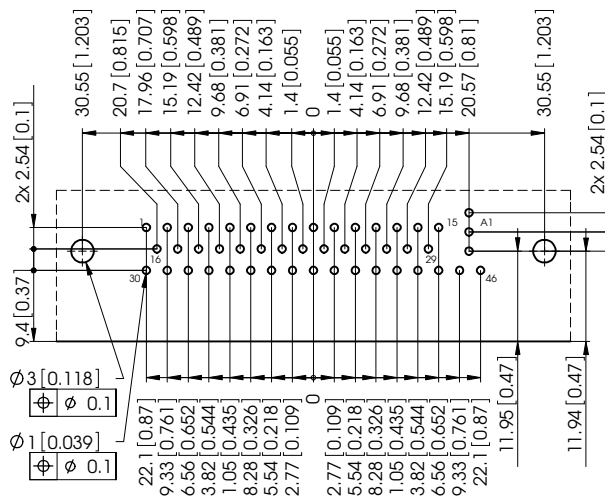





# FBM Coaxial Contacts, Mating Area Dimensions

## FBM Koaxialkontakte, Abmessungen Steckbereich

**Plug**

**Stecker**

**Socket**

**Buchse**

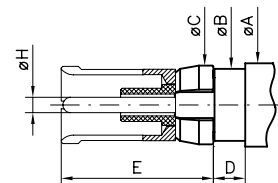
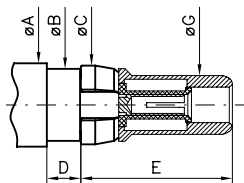

	Plug / <i>Stecker</i>		Socket / <i>Buchse</i>	
	min	max.	min Modi. U*	max. Modi. U*
<b>ØA</b>	—	5,60 (0.220)	—	5,60 (0.220)
<b>ØB</b>	4,75 (0.187)	4,80 (0.189)	4,75 (0.187)	4,80 (0.189)
<b>ØC</b>	5,00 (0.197)	5,40 (0.213)	5,00 (0.197)	5,40 (0.213)
<b>D</b>	2,25 (0.089)	2,45 (0.096)	2,10 (0.083)	2,25 (0.089)
<b>E</b>	—	10,00 (0.394)	—	10,10 (0.398)
<b>ØF</b>	—	2,35 (0.093)	—	—
<b>ØG</b>	3,88 (0.153)	3,92 (0.154)	—	—
<b>ØH</b>	—	—	1,00 (0.039)	1,04 (0.041)

Modification U\* please see page 26

*Modifikation U\* siehe Seite 26*



Hole patterns for FBM coaxial contacts please refer to pages 47 onwards.  
*Lochbilder für FBM Koaxialkontakte siehe ab Seite 47 ff.*



# FBM Coaxial Contacts, 50 Ohm, Straight Cable Termination

## FBM Koaxialkontakte, 50 Ohm, gerader Kabelanschluss

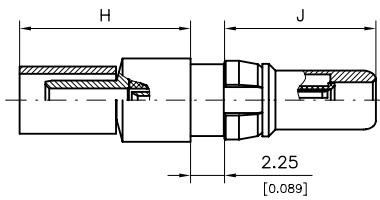

Inner Conductor <i>Innenleiter</i>	Outer Conductor <i>Außenleiter</i>
—	Crimp termination <i>Crimpen</i>
Solder termination <i>Löten</i>	Solder termination <i>Löten</i>

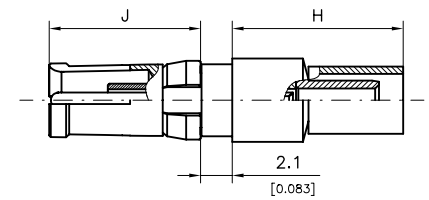

Order Number Plug <i>Bestellnummer Stecker</i>	Type <i>Ausführung</i>	Platings / <i>Oberflächen</i>				Suitable Cables RG- <i>Verwendbare Kabel RG-</i>	Order Number Receptacles <i>Bestellnummer Steckdose</i>
		Mating Area <i>Steckbereich</i>		Termination Area <i>Anschlussbereich</i>			
		Inner Conductor <i>Innenleiter</i>	Outer Conductor <i>Außenleiter</i>	Inner Conductor <i>Innenleiter</i>	Outer Conductor <i>Außenleiter</i>		
FBM002P154M	CuBe	1,3 μm Au	0,8 μm Au	1,3 μm Au	0,2 μm Au	316, double braided <i>doppelt geschirmt</i>	FBM002S154U
FBM003P154M	CuBe	1,3 μm Au	1,3 μm Au	1,3 μm Au	0,2 μm Au	316	FBM003S154U

Other platings on request / *Andere Oberflächen auf Anfrage*  
Tools from page 94 onwards / *Werkzeuge ab Seite 94 ff.*

8 microinches =  $\approx 0,2 \mu\text{m}$   
30 microinches =  $\approx 0,8 \mu\text{m}$

50 microinches =  $\approx 1,3 \mu\text{m}$   
200 microinches =  $\approx 5 \mu\text{m}$

### Dimensions

#### Abmessungen

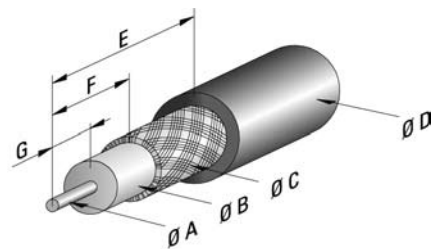
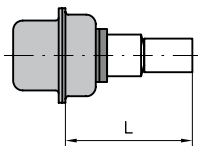

Order Number <i>Bestellnummer</i>	Ø A max.	Ø B max.	Ø C max.	Ø D max.	E	F	G	H	J	L
FBM002P...	0,55 (0.022)	1,55 (0.061)	2,5 (0.098)	3,5 (0.138)	9,5 (0.374)	5,0 (0.197)	3,0 (0.118)	11,3 (0.445)	10,0 (0.394)	16,7 (0.657)
FBM002S...	0,55 (0.022)	1,55 (0.061)	2,5 (0.098)	3,5 (0.138)	9,5 (0.374)	5,0 (0.197)	3,0 (0.118)	11,5 (0.453)	10,1 (0.398)	16,9 (0.665)
FBM003P...	0,55 (0.022)	1,55 (0.061)	2,2 (0.087)	3,2 (0.126)	9,5 (0.374)	5,0 (0.197)	3,0 (0.118)	11,3 (0.445)	10,0 (0.394)	16,7 (0.657)
FBM003S...	0,55 (0.022)	1,55 (0.061)	2,2 (0.087)	3,2 (0.126)	9,5 (0.374)	5,0 (0.197)	3,0 (0.118)	11,5 (0.453)	10,1 (0.398)	16,9 (0.665)



# FBM Coaxial Contacts, 50 Ohm, Straight Semi Rigid Cable Termination

## FBM Koaxialkontakte, 50 Ohm, gerader semi rigid Kabelanschluss

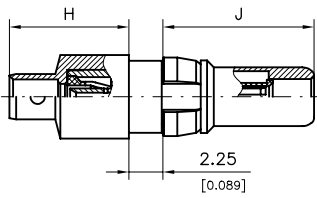

<b>Inner Conductor</b> <i>Innenleiter</i>	<b>Outer Conductor</b> <i>Außenleiter</i>
<b>Crimp termination</b> <i>Crimpen</i>	—
<b>Solder termination</b> <i>Löten</i>	<b>Solder termination</b> <i>Löten</i>

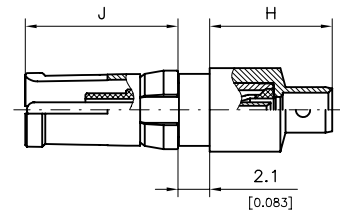

Order Number Plug <i>Bestellnummer Stecker</i>	Type <i>Ausführung</i>	Platings / <i>Oberflächen</i>				Suitable Cables <i>Verwendbare Kabel</i>	Order Number Receptacles <i>Bestellnummer Steckdose</i>
		Mating Area <i>Steckbereich</i>		Termination Area <i>Anschlussbereich</i>			
		Inner Conductor <i>Innenleiter</i>	Outer Conductor <i>Außenleiter</i>	Inner Conductor <i>Innenleiter</i>	Outer Conductor <i>Außenleiter</i>		
FBM004P154M	CuBe	1,3 μm Au	0,8 μm Au	1,3 μm Au	0,2 μm Au	T-Flex 405, Semi rigid 0.086	FBM004S154U
FBM005P154M	CuBe	1,3 μm Au	0,8 μm Au	1,3 μm Au	0,2 μm Au	T-Flex 402, Semi rigid 0.141	FBM005S154U

Other platings on request / *Andere Oberflächen auf Anfrage*  
Tools from page 9 onwards / *Werkzeuge ab Seite 94 ff.*

8 microinches =  $\approx 0,2 \mu\text{m}$   
30 microinches =  $\approx 0,8 \mu\text{m}$

50 microinches =  $\approx 1,3 \mu\text{m}$   
200 microinches =  $\approx 5 \mu\text{m}$

### Dimensions

### Abmessungen

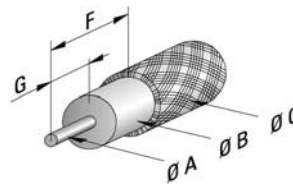
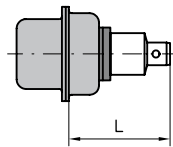

Order Number <i>Bestellnummer</i>	Ø A max.	Ø B max.	Ø C max.	Ø D max.	F	G	H	J	L
FBM004P...	0,55 (0.022)	1,7 (0.067)	2,3 (0.091)	—	3,7 (0.146)	3,1 (0.122)	7,9 (0.311)	10,0 (0.394)	13,3 (0.524)
FBM004S...	0,55 (0.022)	1,7 (0.067)	2,3 (0.091)	—	3,7 (0.146)	3,1 (0.122)	8,1 (0.319)	10,1 (0.398)	13,5 (0.531)
FBM005P...	0,97 (0.038)	—	3,7 (0.146)	—	2,3 (0.091)	2,3 (0.091)	10,6 (0.417)	10,0 (0.394)	16,0 (0.630)
FBM005S...	0,97 (0.038)	—	3,7 (0.146)	—	2,3 (0.091)	2,3 (0.091)	10,8 (0.425)	10,1 (0.398)	16,2 (0.638)



# FBM Coaxial Contacts, 50 Ohm, Straight PCB Termination, 3 Pins

## FBM Koaxialkontakte, 50 Ohm, gerader Leiterplattenanschluss, 3 Anschlüsse

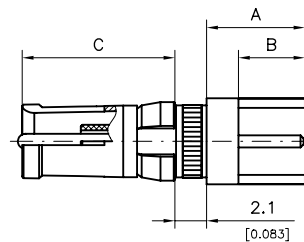
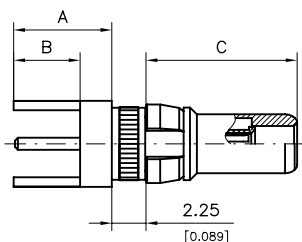

Order Number Plug <i>Bestellnummer Stecker</i>	Type <i>Ausführung</i>	Platings / <i>Oberflächen</i>				Order Number Receptacles <i>Bestellnummer Steckdose</i>
		Mating Area <i>Steckbereich</i>		Termination Area <i>Anschlussbereich</i>		
		Inner Conductor <i>Innenleiter</i>	Outer Conductor <i>Außenleiter</i>	Inner Conductor <i>Innenleiter</i>	Outer Conductor <i>Außenleiter</i>	
FBM006P154MR	CuBe	1,3 $\mu\text{m}$ Au	0,8 $\mu\text{m}$ Au	1,3 $\mu\text{m}$ Au	0,2 $\mu\text{m}$ Au	FBM006S154UR
Other platings on request / <i>Andere Oberflächen auf Anfrage</i>				8 microinches = $\approx 0,2 \mu\text{m}$ 30 microinches = $\approx 0,8 \mu\text{m}$		50 microinches = $\approx 1,3 \mu\text{m}$ 200 microinches = $\approx 5 \mu\text{m}$

### Dimensions of an Example Connector with Coaxial Contact FBM006P... and Signal Contacts P22

#### Abmessungen am Beispiel Steckverbinder mit Koaxialkontakt FBM006P..... und Signalkontakten P22

Order Number <i>Bestellnummer</i>	A	B	C
FBM006P...M	6,5 (0.256)	4,4 (0.173)	10,0 (0.394)
FBM006S...U	6,7 (0.264)	4,4 (0.173)	10,1 (0.398)

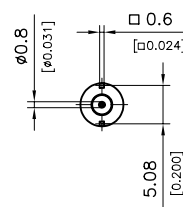
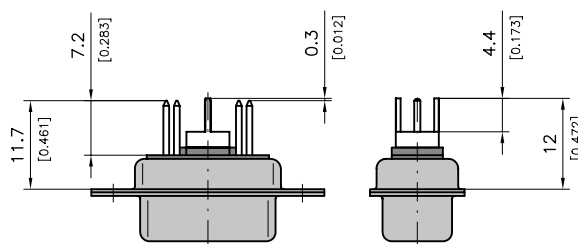

Side view without signal contacts!  
*Seitenansicht ohne Signalkontakte!*



# FBM Coaxial Contacts, 50 Ohm, Straight PCB Termination, 5 Pins

## FBM Koaxialkontakte, 50 Ohm, gerader Leiterplattenanschluss, 5 Anschlüsse

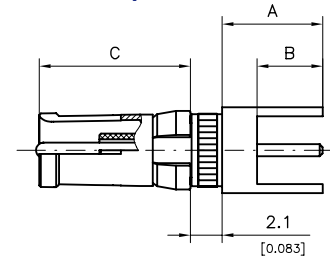
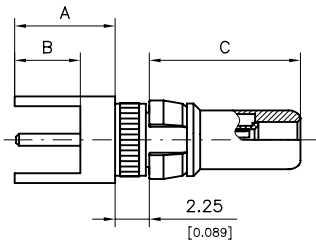

Order Number Plug <i>Bestellnummer Stecker</i>	Type <i>Ausführung</i>	Platings / <i>Oberflächen</i>				Order Number Receptacles <i>Bestellnummer Steckdose</i>
		Mating Area <i>Steckbereich</i>		Termination Area <i>Anschlussbereich</i>		
		Inner Conductor <i>Innenleiter</i>	Outer Conductor <i>Außenleiter</i>	Inner Conductor <i>Innenleiter</i>	Outer Conductor <i>Außenleiter</i>	
FBM007P154MR	CuBe	1,3 $\mu\text{m}$ Au	0,8 $\mu\text{m}$ Au	1,3 $\mu\text{m}$ Au	0,2 $\mu\text{m}$ Au	FBM007S154UR
Other platings on request / <i>Andere Oberflächen auf Anfrage</i>				8 microinches = $\approx 0,2 \mu\text{m}$	50 microinches = $\approx 1,3 \mu\text{m}$	
				30 microinches = $\approx 0,8 \mu\text{m}$	200 microinches = $\approx 5 \mu\text{m}$	

### Dimensions of an Example Connector with Coaxial Contact FBM007P... and Signal Contacts P22

#### Abmessungen am Beispiel Steckverbinder mit Koaxialkontakt FBM007P... und Signalkontakten P22

Order Number <i>Bestellnummer</i>	A	B	C
FBM007P...M	6,5 (0.256)	4,4 (0.173)	10,0 (0.394)
FBM007S...U	6,7 (0.264)	4,4 (0.173)	10,1 (0.398)

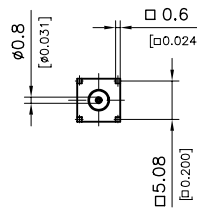
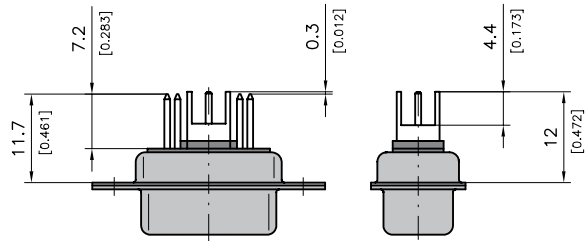

Side view without signal contacts!  
*Seitenansicht ohne Signalkontakte!*



# FBM Coaxial Contacts, 50 Ohm, Right Angled PCB Termination, 3 Pins

## FBM Koaxialkontakte, 50 Ohm, abgewinkelter Leiterplattenanschluss, 3 Anschlüsse

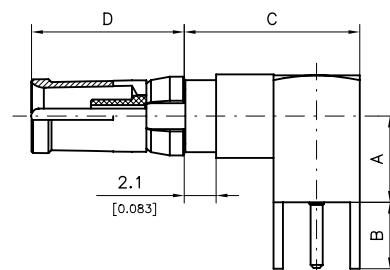
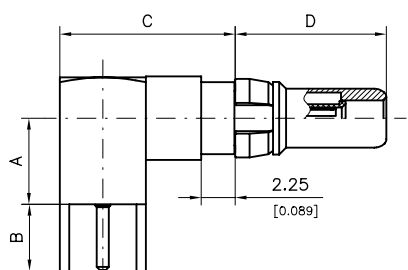

		Platings / Oberflächen				
		Mating Area Steckbereich		Termination Area Anschlussbereich		
Order Number Plug Bestellnummer Stecker	Type Ausführung	Inner Conductor Innenleiter	Outer Conductor Außenleiter	Inner Conductor Innenleiter	Outer Conductor Außenleiter	Order Number Receptacles Bestellnummer Steckdose
FBM001P154MR	CuBe	1,3 μm Au	0,8 μm Au	1,3 μm Au	0,2 μm Au	FBM001S154UR
Other platings on request / Andere Oberflächen auf Anfrage				8 microinches = ≈0,2 μm		50 microinches = ≈1,3 μm
				30 microinches = ≈0,8 μm		200 microinches = ≈5 μm

### Dimensions of an Example Connector with Coaxial Contacts FBM001P... and Signal Contacts P5

#### Abmessungen am Beispiel Steckverbinder mit Koaxialkontakten FBM001P... und Signalkontakten P5

Order Number Bestellnummer	A	B	C	D
FBM001P...M	5,7 (0.224)	4,4 (0.173)	11,6 (0.457)	10,0 (0.394)
FBM001S...U	5,7 (0.224)	4,4 (0.173)	11,6 (0.457)	10,1 (0.398)

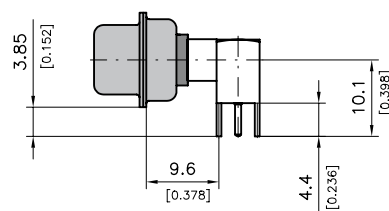
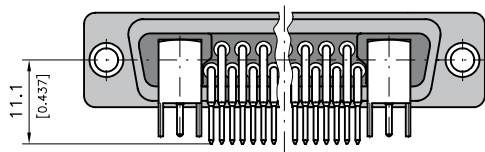
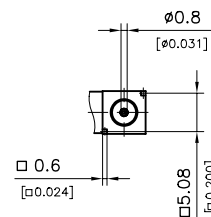

Side view without signal contacts!  
Seitenansicht ohne Signalkontakte!